

Sunny Boy 2000

Technical Description

Version 1.2

Sunny Boy 2000
The Transformerless String Inverter
for Photovoltaic Plants

Alteration Review

Document- Number SB2000	Version and Alteration Review ¹⁾		Comments	Author
-11-EE0101	1.2	A	New document based on translation of German version SB2000-11:ED2000, changes of input current, drilling template modified	Laschinski (translated by Kreter)

¹⁾ A: Alterations due to faulty documents or improvement of the documentation

B: Alterations maintaining full or upward compatibility

C: Alterations limiting or excluding compatibility

	Name	Date	Signature
Approved	Bremicker	27.07.2007	

Explanation of Symbols used in this Document

To enable optimal usage of this manual and safe operation of the device during installation, operation and maintenance routines, please note the following description of symbols:



This indicates a feature that is important either for optimal and comfortable usage or optimal operation of the system.

Example: "Useful C routines for this purpose are on the support disk."



This indicates a fact or feature very important for the safety of the user and / or can cause a serious hardware defect if not appropriately applied.

Example: "Disconnect the mains plug before opening the case!"



This indicates an example.

Contents

1	Introduction.....	6
2	System Description	7
2.1	String Technology.....	8
2.2	Diagnosis and Communication	10
2.3	Technical Design of the Sunny Boy 2000	11
3	Installation	16
3.1	What must be done in case of transport damages?	16
3.2	Mounting.....	17
3.3	Electric Connection	22
3.3.1	Mains Connection.....	24
3.3.2	Connection of the PV-panels.....	26
4	Commissioning.....	30
5	Operation and Failure Indication LEDs	31
6	Plant Monitoring and Diagnosis.....	48
6.1	Data Transmission via Powerline.....	48
6.2	Data Transmission with a Separate Data Cable	51
6.2.1	Upgrading or modification of the Sunny Boy interface	57
6.3	Graphic User Interface under Windows	61
6.4	Measuring Channels and Messages of the Sunny Boy	63
6.5	Measurement Precision	65
7	Troubleshooting.....	66
8	Warranty Regulations and Liability	68
9	Technical Data	70
10	Appendices.....	76

Important Safety Notice:

The Sunny Boy String Inverter may only be opened by qualified personnel for both installation and maintenance. The device can still be charged with very high hazardous voltages even when disconnected. For optimal safety closely follow all steps as described in chapter 3 'Installation'.

1 Introduction

Thank you very much for purchasing a Sunny Boy String Inverter.

By purchasing a Sunny Boy^{® 1} String Inverter you have decided to use one of the most advanced devices for modular PV system technology. The Sunny Boy inverters are the first systems that utilize the String Technology developed by SMA and convince with their outstanding qualities concerning efficiency and reliability.

The Sunny Boys comply with all regulations from the VDEW (Association of German Electricity Producers) for supplementary grid feeding to the low voltage electricity grid of the utility. This includes the regulations of the employee association (Berufsgenossenschaft für Feinmechanik und Elektrotechnik) concerning the “Independent Disconnection Device“ known as MSD (Mains monitoring device with allocated Switching Devices) and the regulations of DIN VDE 0126. Furthermore the Sunny Boy complies with the EMC and low voltage regulations and the according European harmonized standards as certified in the CE declaration (see appendix).

In the following you will find the technical description of the Sunny Boy 2000. Don't worry about its size, it is not necessary to read everything. This technical description is both installer's guide and user manual, so it is used as reference for the commissioning and as guideline on how to use all functions of the inverter optimally and how you can extend your existing PV-plant.

¹ *Sunny Boy* is a registered Trademark of SMA Regelsysteme GmbH

2 System Description

Reducing the emission of carbon dioxide and reducing other environmental emissions resulting from energy conversion is becoming more and more important. Renewable energy sources can make an important contribution to solve this problem. The direct conversion of solar radiation to electric energy (photovoltaics) will play a substantial role in this essential matter.

Supplementary grid feeding includes the conversion of the DC voltage from the PV-panel to grid conform AC voltage with so-called "inverters" and the subsequent connection to the mains in the house distribution.

Here the solar energy system provides all consumers with electric power (household devices, lights etc.). In case that not enough energy is produced the additionally necessary energy is obtained from the grid. A potential surplus of energy is fed into the local grid and is therefore available for other consumers. This way every single kilowatt-hour is used and the electricity companies power plants are relieved. In the most simple case a grid connected solar energy plant therefore consists of two components: the PV-panel and the inverter.

2.1 String Technology

The experience with several thousand grid connected PV-systems in Europe with an output range from one to several hundred kilowatts has shown us that the costs for connecting and monitoring the PV-system add up to almost 50 % of the cost of the entire system. The reduction of these costs, especially the costs for the cabling on the DC side and the subsequent distribution on the AC side, along with a drastic simplification of PV system design were the reasons for developing the string-technology from SMA.

The String-Inverter connects a small number of serially connected PV-panels (strings) with the local electricity grid. Even large PV-systems can be created with this method - the large PV-system then consists of several strings each with a single inverter. The electricity is then collected on the AC side - therefore the expensive and work intensive DC cabling on the DC side is not necessary anymore. No additional planning is required.

SMA is the European market leader for inverters in photovoltaic applications with over 53 MW of installed inverter power in over 38,000 single units in a power range from 700 W up to 500 kW (figures from 12/2000). The Sunny Boy is the result of a dedicated development resulting from the substantial experience with utility interactive inverters for photovoltaics.

The most various system designs can be modularly created with the **Sunny Boy products**.

- **Sunny Boy 700:**
The small model for little PV-plants and simple extension possibilities (3 input voltage and power ranges)
- **Sunny Boy 850:**
The output optimized inverter for PV-plants with 1 kWp.
- **Sunny Boy 1100E:**
The inverter for PV-plants in a power range of 1.5 kWp with extended input voltage range
- **Sunny Boy 2000:**
The transformerless String-Inverter with extended input voltage range and excellent efficiency, ideal for large PV-plants.
- **Sunny Boy 2500:**
The most powerful string inverter with electric separation, ideal for large-scale plants.
- **Sunny Display**
The optional integrated LCD display for direct data acquisition.
- **Sunny Data:**
The PC-program for communication with your Sunny Boy inverters.
- **Sunny Boy Control:**
The intelligent terminal for your PV-plant for data acquisition and evaluation.
- **Sunny Data Control:**
The PC-program for visualization of data from your Sunny Boy Control

2.2 Diagnosis and Communication

The modular PV system technology leads to a spread out distribution of the Sunny Boy String Inverters. A simple and fast function monitoring of the status and measured values for each single Sunny Boy can be achieved with only a few system components. The data collected is either displayed on the optional Sunny Display integrated in the front panel of the Sunny Boy or on the LCD of the Sunny Boy Control or shown on the screen of a PC running the according SMA software. Two programs *Sunny Data* and *Sunny Data Control* are based on a comfortable Windows GUI and allow the user to process or print out the data with other programs such as MS Excel.

The signal transmission between the PC and the single inverters is normally done via Powerline communication (see chapter 6.1: 'Data Transmission via Powerline'). The Sunny Boy String Inverters support the following monitoring concepts developed by SMA:

- PC with Sunny Data for Windows for small and medium size PV-plants
- Sunny Boy Control as stand-alone controller for any PV-plant size
- PC with Sunny Data Control for Windows together with a Sunny Boy Control

Communication based on one of the above concepts supports the following functions:

- Continuous acquisition of operation data of all connected Sunny Boys
- Supervision of operating states and failure indication
- Spot value transmission from one or several selected Sunny Boys
- Identification of failures in the single strings
- When using a PC: graphical representation of the data from single Sunny Boys or comparison of the data of several ones
- Modification of operation parameters to optimize the entire plant

2.3 Technical Design of the Sunny Boy 2000

The main feature of the Sunny Boy 2000 is the simple and absolutely sturdy design with outstanding reliability and high efficiency. The PV-plant's DC voltage is converted to a DC circuit with a high frequency step-up converter (16 kHz). From this intermediate circuit the grid feeding is done directly with an IGBT bridge.

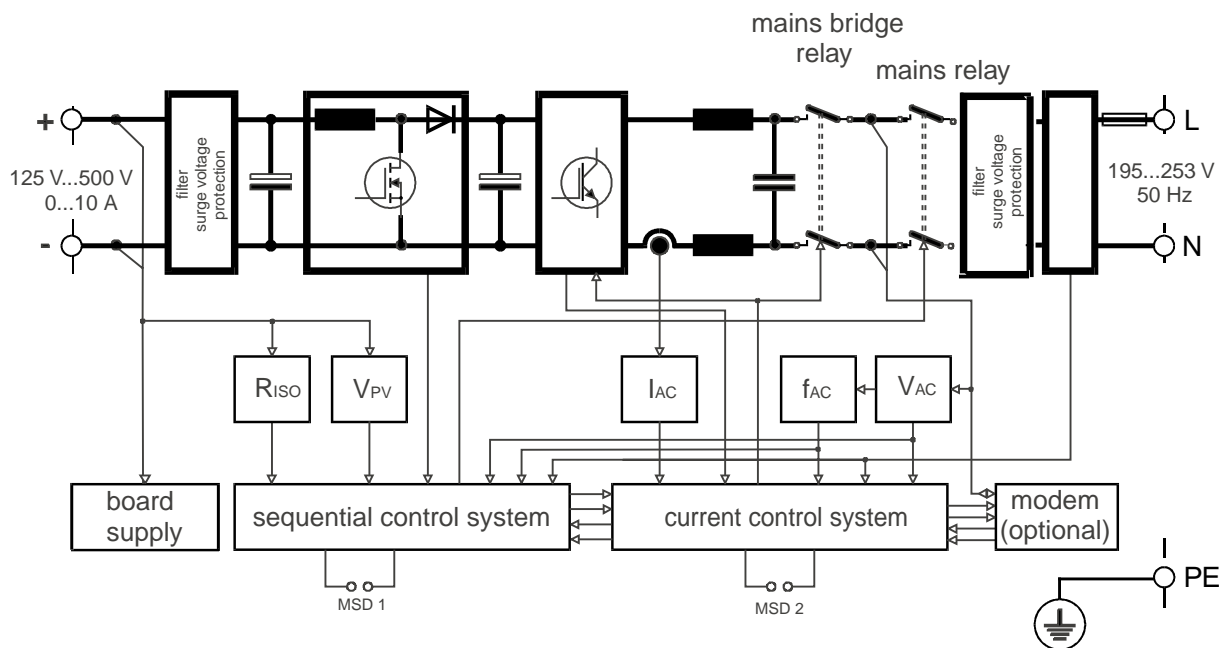

Fig. 2.1: Block Circuit Diagram of Sunny Boy 2000

The string inverter's nominal power is dimensioned for the serial connection of a maximum of 20 modules (with 36 to 40 cells each). It is possible to connect two separate strings parallel to the Sunny Boy depending on the PV-module type used.

The management of feeding current with a one-chip micro-controller guarantees an absolutely sine-formed curve with extremely low harmonic distortion. The SCS provides fully automatic functioning of the system as well as the MPP-tracking (MPP = detection of the voltage point with maximum power, **Maximum Power Point**). Unnecessary losses resulting from stand-by operation and during operation are avoided.

The heat sink of the Sunny Boy disposes of the inevitable power loss resulting from switching the power semiconductors. It is large enough to enable the Sunny Boy to

continuously feed nominal power to the grid even in case of high ambient temperature (e.g. when the Sunny Boy is installed directly under the roof). The Sunny Boy 2000, which can feed peak power of 2000 watts to the grid, has an integrated heat sink temperature monitoring. When the maximum temperature is exceeded (e.g. due to high ambient temperature or insufficient heat dissipation) the Sunny Boy reduces the input current so that it is not overheated and still feeds maximum possible power to the grid.

The sequential control system is extended by the possibility to communicate with the corresponding SMA tools Sunny Data or Sunny Data Control for data analysis. This feature makes the Sunny Boy a universal system either used as standalone device or as part of a large PV-plant with centralized operation monitoring and evaluation.

The grid is simultaneously monitored by two independent one-chip microcomputers and fully complies with all grid feeding regulations of the VDEW and the employee associations (MSD with evaluation of the grid impedance and GFCI). The Sunny Boy therefore can be connected to the grid at any point of the house grid resulting in most simple installation. The relevant guidelines, regulations and standards must of course be kept to.

The Sunny Boy is equipped with a stainless steel enclosure which is dustproof and water-proof (protection class IP65). This protection class allows mounting at nearly any place with ambient temperatures of -25°C to $+60^{\circ}\text{C}$.

Even with small PV-plants personnel protection is a priority. The Sunny Boy is equipped with an all-pole sensitive RCB (residual current breaker) for 30 mA with a so-called shifting base. This RCB and the insulation monitoring make sure any insulation failure is detected immediately and the plant is switched off. Due to the shifting base real grounding failures can be distinguished from normal ground discharge currents of the PV-panel. Of course the relevant standards e.g. for electromagnetic compatibility (EMC) and safety technology are also complied with.

Automatic Grid Disconnection Device (MSD)

This chapter covers the safe disconnection of the inverters in case of a grid disconnection from the electricity company. That means that in the case that the electricity company disconnects part of its grid e.g. in order to conduct maintenance work on the grid sufficient safety for maintenance personnel must be guaranteed. In order to guarantee this safety the employee association for precision mechanics and electric engineering developed a safety concept that became part of the VDEW guidelines in August 1994.

The Sunny Boy String Inverter is absolutely restricted to supplementary grid feeding operation - i.e. the grid feeding must stop in case the local electricity supply is cut off. The Sunny Boy is equipped with a certified automatic disconnection device for the safe disconnection when the external grid is down in order to avoid islanding. This disconnection device is officially certified by the employee associations.

The device is a "Selbsttätige Freischaltung für Eigenerzeugungsanlagen einer Nennleistung $\leq 4,6$ kVA mit einphasiger Paralleleinspeisung über Wechselrichter in das Netz der öffentlichen Versorgung" (i.e.: "Automatic Disconnection Facility for Photovoltaic Plants with a Rated Output ≤ 4.6 kVA and a Single Phase Parallel Feed by Means of an Inverter into the Public Low-Voltage Mains").

For maximum safety it is important that the automatic disconnection device consists of two independent units for mains monitoring, each equipped with a disconnecting device and connected in series. Each of these devices permanently supervises the parameters of the connected grid by checking the voltage, frequency, and impedance. The redundant design and an automatic self-test before each connection to the mains guarantee its reliable function.

While former disconnection devices for islanding detection only checked the voltage of the connected three-phase mains, the new concept uses above all the mains impedance alterations in the one-wire mains (feeding phase) as a measured value for disconnection. In addition voltage and frequency in the one-wire mains are also checked.

Criteria for disconnecting the Sunny Boy from the grid:**• Mains impedance**

- The inverter does not start feeding to the mains if a maximum impedance value is exceeded ($Z_{AC} = 1.25 \Omega$).
- If the mains impedance changes by a certain value in a certain time ($Z_{AC} \geq 0.5 \Omega$) or if it exceeds a maximum value ($Z_{AC} \geq 1.75 \Omega$) during grid feeding, the inverter will be disconnected from the mains within 5 s.

• Mains voltage

- In case the mains voltage exceeds or falls below a range of -15/+10 % of the nominal mains voltage V_N , the Sunny Boy is disconnected from the mains within 0.2 s.

• Mains frequency

- If the frequency exceeds a range of ± 0.2 Hz of nominal mains frequency f_N with a mains voltage of -30/+15 % of nominal mains voltage this must additionally cause a mains disconnection within 0.2 s.

• Insulation

The quality of insulation in the entire system is guaranteed by two independent monitoring activities:

- The inverter will only start feeding to the grid if its resistance to ground (insulation resistance) exceeds 2 M Ω .
- During operation the fault current (to earth) is continuously monitored. If this current exceeds 95 mA or if the value increases or decreases by more than 30 mA the Sunny Boy is disconnected from the grid within 0.2 s.

The new concept of the Sunny Boy provides maximum safety. Nevertheless, the installation expenses of a solar plant are drastically reduced because now a one-phase connection of the inverter with MSD is sufficient.

The grid impedance is measured by every Sunny Boy just at the place where it is connected to the mains. The measured grid impedance consists of the impedance of the public grid and the mains impedance in the house (from the house connection to the Sunny Boy). A drastic grid impedance increase caused by the connection to the Sunny Boy must therefore be avoided.



We recommend to pay attention to an impedance increase due to the distance between house connection and Sunny Boy (further information is given in chapter 3.3.1, 'Mains Connection').

The VDEW regulations demand a device test which the inverter manufacturer must have performed by a qualified certification organization. Furthermore, the manufacturer has to check the function of the mains disconnection device of every single unit before delivery. For the owner of the PV-plant this means:

- The time-consuming disconnection device testing by the electricity company and the installer is not necessary
- The previously required periodic tests are not necessary.

Important arguments for the omission of repeated tests are the redundant design and the recurring self-test of the disconnection device. During every new mains connection the correct function of the mains monitoring is checked in order to guarantee that the according switching devices (transistor bridge, relay) are working and able to disconnect the load circuit. In case of a negative test result the complete self-test will be repeated. If the negative result occurs again, the disconnection device has to be checked by qualified personnel. In this case the operation will be blocked and indicated to the user by the LEDs. This operating state will be recorded and cannot be overridden with simple switching operations from the outside (signals via the serial interface, resetting the internal computers, switching the device off and on etc.). This ensures that only qualified personnel can unlock the device for grid feeding after testing the disconnection device has failed.

3 Installation



The installation of the Sunny Boy String Inverter must be conducted by qualified personnel. The installer must be approved by the local electricity company.

Please read this chapter carefully before installation.

Pay attention to all safety requirements, the connection regulations imposed by the local electricity company and the VDE regulations.

3.1 What must be done in case of transport damages?

The inverters are thoroughly checked before they are shipped. Even though they are delivered in a sturdy packaging (which can be recycled) the inverters can be damaged in transit.

Please inspect your inverter thoroughly after it is delivered. If any damages can be detected on the packaging that could make you conclude the contents is damaged or if you detect that the inverter is damaged please immediately notify the forwarding company.

SMA or your local supplier can help you in this matter. In any case a declaration of transport damage must be made within 6 days upon receipt of the product and must be stated in writing directly to the forwarding agent. If it is necessary to return the inverter to the manufacturer please use the packaging the inverter was sent in (if it is still functional). Only then can transport damages be avoided as far as possible. SMA cannot provide warranty for damages resulting directly or indirectly from unsuitable transport packaging.

3.2 Mounting

Placement of the Sunny Boy

The Sunny Boy is a highly integrated electronic device, therefore sensitive to humidity **within** its case.



If the Sunny Boy is placed outside air humidity during installation should not be extremely high (e.g. in case of fog) - pay special attention that it does not rain. If moisture is enclosed in the case it will eventually condense within the device which could damage the electric components and lead to failure of the inverter. SMA cannot provide warranty for damages resulting directly or indirectly from faulty installation.

A suitable position must be found for the inverter/s while the PV-plant is designed. It is important to take the following criteria into account:

Criteria for device mounting:

- Due to the high protection class IP65 the installation is possible indoors as well as outdoors.
- If possible, do not expose the inverter to direct moisture despite IP65.
- Keep the DC cabling from the solar generator to the inverter as short as possible.
- Avoid installation in the living area because a slight noise emission is possible.
- Avoid mounting on resonant parts (e.g. thin wooden panels, plaster panels, etc.).
- Provide accessibility for installation work and later servicing.
- Installation in eye-height allows easy reading of the operating indicators (LEDs).

Please note the following points in any case:



- The mounting ground must be firm.
- The ambient temperature must lie between -25 °C and $+60\text{ °C}$.
- Take into account mains impedance at the feeding point, see paragraph “Autonomous Grid Disconnection Device (MSD)” (p.13 et seq.) and chapter 3.3.1, ‘Mains Connection’.
- Do not expose the string inverter to direct sunlight (if necessary install a shading roof).
- A minimum distance of 200 mm must be clear above the inverter for ventilation, i.e. no cupboards, ceiling, etc.
- Free air circulation around the case must not be obstructed.
- If you are installing the Sunny Boy in a cabinet etc., air circulation must be sufficient for heat dissipation - provide external ventilation.
- The heat sink can reach a temperature of more than 80 °C .
- Mount the inverter in a correct position. See below

CAUTION!

Mount the inverter upright or tilted to the back.

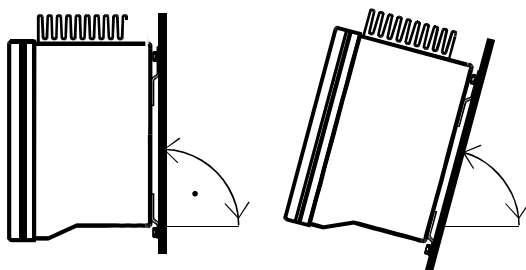

Never mount tilted to the front!

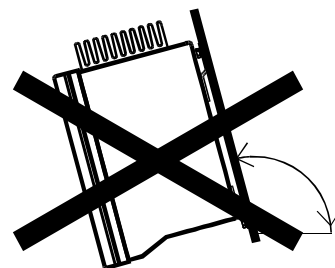

Fig. 3.1: Recommended outside mounting of the inverter - side view

Packing list for mounting and installation

The following components provide for safe and simple installation of the Sunny Boy and are included in the packing list. The Sunny Boy is prepared for mounting at PV-panels with the MultiContact plug connector system. For PV-panels where this plug system is not used SMA offers an adapter set (SMA material no. SWR1500-MC).

	Sunny Boy 2000
Cable gland PG 16 with corresponding lock nut	2 pc.
Blank screwed joint PG 16	1 pc.
Washer M5, plastic for fixing to lid	4 pc.
Drilling template	1 pc.
Plug for mains connection	1 pc.
Seal for Multi-Contact plug	1 pc.
Seal for Multi-Contact socket	1 pc.

Table 3.1: Packing list for mounting and installation

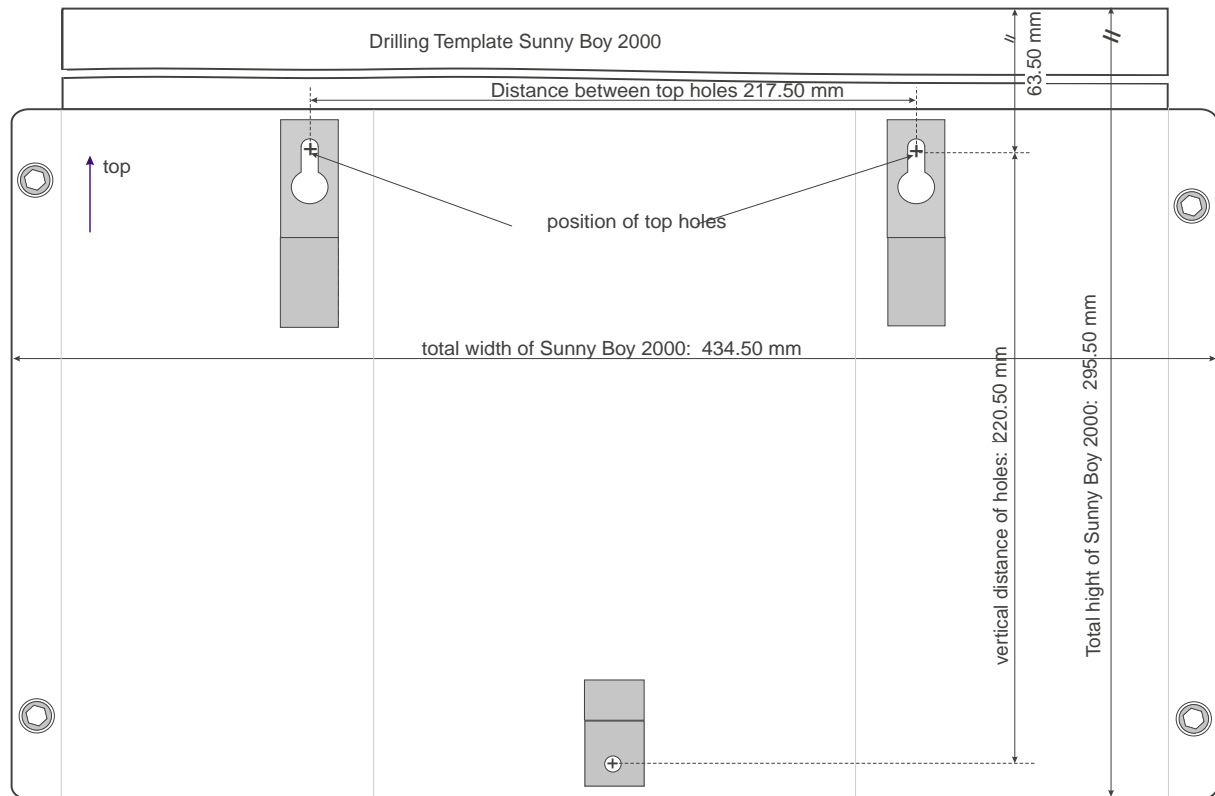

Fig. 3.2: Drilling Template

Preparing the Mounting

The Sunny Boy is mounted on its back with three metal straps on a firm surface. Three screws and the corresponding dowels are necessary. The screws and dowels are not included and have to have a sufficient size. We recommend 6 mm screws and 8 mm dowels.



For outside mounting use stainless steel material (screws, washers etc.).

The Sunny Boy is mounted to the wall by three metal straps on the back of the device (see Fig. 3.2).

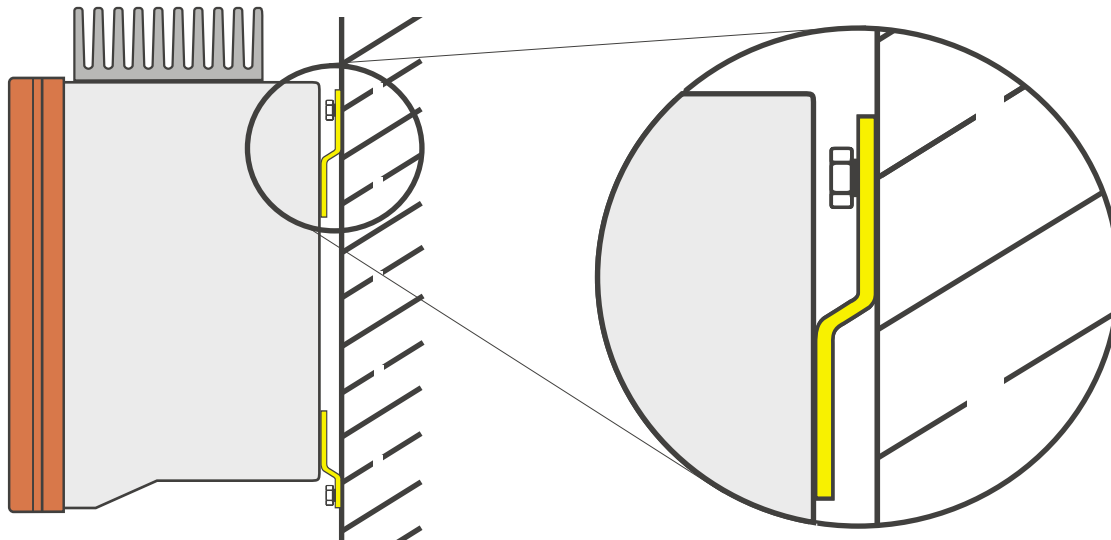

Fig. 3.3: Mounting to wall, side view

Metal straps for mounting:

The top straps take the load, the bottom is screwed down in order to prevent tilting off the wall.

Securing the Sunny Boy against lifting up:

After the Sunny Boy has been hanged into the top screws fasten the bottom screw to secure against lifting up.

Mounting to the wall

- Mark the holes with the drilling template.
- Drill the holes (and put in the dowels), put in the screws of both top holes and screw them in until ca. 4 mm are looking out.
- Hang the inverter into the two top screws.
- Fasten the bottom screw in order to prevent lifting up.
- Check the mounting of the inverter.

3.3 Electric Connection

The electric connection of the Sunny Boy can be done once the device is correctly mounted in its position.

The PV-modules are connected to the inverter with safe to touch snap cable connectors accessible from outside.

On the other hand, the mains connection is located inside the string inverter. It is a three-cable connection (L, N, PE) for cables with a cross section of up to 4 mm². At the bottom of the case there are two openings suitable for PG16 fastening clamps to insert the cable.



The electric connection of the Sunny Boy and the connection to the input and output cabling must be done in the order described here. Following this order the installer will make sure not to open contacts under load and exclude high voltages during the installation.

- 1. Connect mains**
- 2. Close inverter case**
- 3. Connect PV-panels (remove seals from the cable ends and plug in the cables to the inverter)**
- 4. Switch on fuse of the phase**

If at any time the inverter has to be dismantled please note that the device must be disconnected in the opposite order. Always keep in mind to wait for at least 30 minutes before opening the inverter after disconnecting it.

The PV-panel may never be disconnected from the Sunny Boy (pulling out the plug connectors) while under load, i.e. during the inverter feeds to the grid. Always disconnect the mains before.

Preparing the connection

The front panel of the inverter must be removed in order to attach the output wiring - this is done by removing the four screws (M5) accessible from the front.



The front panel is grounded with a tab and receptacle connector - carefully remove the green-yellow cable in order to remove the front panel.

You can now see the position of relevant modules and clamps in the open case in front of you. You will find:

- The plug connectors for PV-panel connection
- The mains terminals (in the lower middle to right section)
- The mains fuse (in the lower middle to right section)

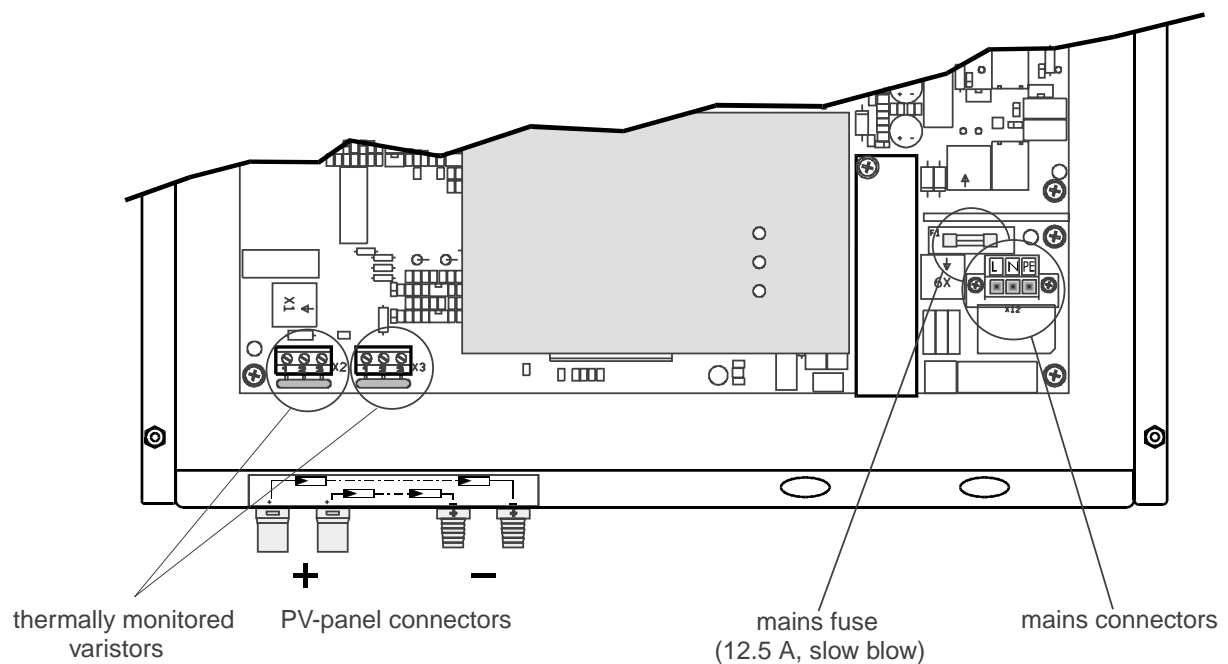

Fig. 3.4: Connectors in the Sunny Boy 2000

3.3.1 Mains Connection

The Sunny Boy must be connected to the mains with three cables (L, N, PE).



We recommend a 16 A fuse with 'B' characteristics for the circuit the Sunny Boy is connected to. No consumers are allowed on this circuit or else must be fused separately.

The inverter autonomously monitors ground fault currents of the PV-panel (PV-modules, cabling and inverter) and disconnects the plant from the mains if the discharge current changes drastically by ≥ 30 mA. The inverter distinguishes between real ground fault currents and normal capacitive discharges. Conventional AC-sensitive RCBs with a sensitivity of 30 mA could result in "false alarms" due to the normal capacitive discharges resulting in disconnection.



The installation of an additional RCB in the mains connection cable is therefore not advisable.

If the user wishes to install an additional RCB anyway this must have at least a sensitivity of 100 mA.



Note that accessible components of the PV-system (metal frames, aluminum foil shielding of the PV-panels, mounting racks etc.) must be grounded in order to provide a safe discharge from the system during operation.

A sufficiently thick cable should be used to prevent an increase of the grid impedance (internal resistance of the grid) resulting from the connection between the Sunny Boy and the in-house distribution network - $Z_L \leq 0.5 \Omega$ is recommended. (More about this in paragraph "Autonomous grid disconnection device (MSD)" in chapter 2.3, page 13).



The impedance value results from the mains impedance at the house connection point plus all resistance values of additional cables and connection points.



Please note that a cable of:

20m length/1.5 mm² cross section already has a resistance of ca. 0.48 Ω!

35m length/ 2.5 mm² cross section already has a resistance of ca. 0.50 Ω!

The Sunny Boy is equipped with two PG16 sized openings on the bottom of the inverter for cable insertion. In most cases only one cable opening is needed for Powerline.



Before inserting the Powerline into the device check whether it is disconnected from the mains.

- Insert the according PG-fastening into the case and secure it with a bolt from inside.
- Strip the insulation off the end of the cable and insert it into the inverter.
- The inverter is delivered with a plug - connect this inside the inverter according to the plug documentation.
- Check that the plug is connected correctly and that it cannot be removed. Insert the plug into the appropriate opening and secure it with the two screws.
- Tighten the PG16 cable sealing.
- Close the remaining reserve opening with a PG seal.
- Close the inverter and tighten the 4 screws.



Don't forget to attach the PE grounding cable (green-yellow) to the tab connector on the lid!

- Check the correct position of the front panel and the LEDs.

3.3.2 Connection of the PV-panels

The PV-panel's DC voltage is connected to the inverter with safe to touch snap connectors in order to provide maximum protection. The inverter is equipped with connectors especially designed for PV-plants from Multi-Contact^{®2}.



Make sure the „+“ and „-“ poles of the PV-panel are correctly connected to the respective MultiContact plug connectors at the bottom of the Sunny Boy.

Depending on the type of PV-panels you must distinguish between connecting one single or two parallel strings. In order to be able to connect two strings there are two connectors for plus and minus pole each. The connectors are switched parallel inside the inverter.



Seal the unused connectors if you are using only one string.

In order to provide maximum safety during initial installation it is necessary to have the plus and minus pole from the PV-panels clearly separated from the PE (protective earth).

² MC[®] is a registered trademark of Multi-Contact.

Before connecting the PV-panel to the Sunny Boy check the installation is isolated from earth by:

- Determining the DC voltage between protective earth (PE) and the plus and minus poles of the PV panel.

If you measure stable voltages there is a ground fault in the PV-panel or its cabling. You can assess where the failure is located from the ratio of the different voltages measured. It is essential to solve this failure before continuing the installation!

- Acquiring the electric resistance between protective earth (PE) and the plus and minus poles of the PV-panel.

A low resistance (< 2 MΩ) shows there is a high-resistance ground fault of the PV-panel. It is essential to repair this failure before continuing the installation!

After you have checked the PV-panel is isolated from earth you can establish the electrical connection to the Sunny Boy. Remove the seal from the plug connectors at each cable end of the PV-panel and firmly insert them into the Sunny Boy 2000. As soon as the PV-panel has been connected to the Sunny Boy with the MC[®] plug connectors the internal PV-panel voltage is on.

Safety notice

The resistance of the plus and minus pole and PE is measured each time before the inverter starts feeding to the grid. If the resistance is below 2 M Ω the inverter does not begin feeding the grid and the red warning LED goes on (see chapter 5: 'Operation and Failure Indication LEDs').



When the PV-panel is first connected to the Sunny Boy an electric potential to protective earth arises on the plus and minus lines equaling the PV-panel voltage (string voltage).

The monitoring of the isolation results in a minor electric connection between the plus, minus and PE. The high resistance of the monitoring circuit results in the fact that normally no danger arouses from this circuit, even though certain voltage meters show a voltage between the case of the inverter and the plus and minus pole.

A highly dangerous voltage is on between the plus and minus poles of the PV-panel and PE also during grid feeding by the (transformerless) Sunny Boy 2000.



Always provide a sufficient connection of metal parts of the PV-panel (metal frames, aluminum foil from the modules themselves, construction holding the panels etc.) to the ground to allow that voltages are discharged during operation.



The PV-panel may never be disconnected from the Sunny Boy (pulling out the plug connectors) while under load, i.e. during the inverter feeds to the grid. Always disconnect the mains first.



The plug connectors can be damaged by an electric arc occurring when separating the PV-panel while feeding to the grid. In this case both parts of the relevant plug connector have to be exchanged.



Caution: The input capacitors are still loaded even after disconnecting the PV-panel from the inverter. Therefore the inverter still can have high voltages for approx. 30 minutes even after disconnecting the AC and DC side. The DC voltage can be up to 500 V. It is essential for qualified personnel to wait approx. 30 minutes after disconnecting the device before opening it in order to let the harmful voltages discharge.

4 Commissioning



Do not put anything on top of the inverter case during operation.



The heat sink on top of the Sunny Boy can have temperatures above 80°C. **Danger of burning.**



Make sure that all remaining openings for cable insertion at the bottom of the Sunny Boy have been closed with the seals included in delivery.

First switching on

The Sunny Boy 2000 can be put into operation as soon as it has been connected electrically and the grounding of the PV-panel's metal frame has been checked.

- Connect the inverter to the grid by switching on the fuse of the phase the inverter is connected to.

The Sunny Boy will begin operation as soon as the input voltage is sufficient. How much power the Sunny Boy feeds to the grid depends on the amount of PV power supplied by the PV-panel.

When designing the Sunny Boy SMA kept the internal consumption as low as possible. The Sunny Boy requires a maximum of 7 W out of the PV power supplied by the PV-panel.

Please note that despite an extremely low radiation the PV-panel is under load due to the inverter's internal consumption. The real open circuit voltage is only produced with higher solar radiation when the internal consumption is negligible compared to the power supplied by the PV-panel.

The inverter's operating condition is indicated with the 3 LEDs on the front - a detailed description will be given in chapter 5: 'Operation and Failure Indication LEDs'.

5 Operation and Failure Indication LEDs

The inverter normally operates automatically, without user interaction and without any maintenance. The inverter automatically turns itself off when a grid feeding is not possible (e.g. at night).

The Sunny Boy automatically starts grid feeding the next day once the solar radiation is high enough. The inverter switches to idle mode if the radiation and the resulting electric input energy are too low.

Each time the Sunny Boy starts up it runs a number of self test and safety procedures which the user does not notice.

The user can obtain the inverters operating status from the three LEDs integrated in the lid. (See Table 5.1: Operation indication overview).

The green LED 'Operation' describes the current operation of the inverter, see paragraph 'Operation Indicator' starting on page 35.

The red LED warns the user that an 'Earth Fault' has occurred. A description of this situation and what has to be done in that case is given in paragraph 'Earth Fault Indicator' starting on page 38.

The yellow LED 'Failure' indicates an internal or external failure that keeps the inverter from feeding the grid. The specific causes for this and how to avoid them are described in paragraph 'Failure Indicator' starting on page 42.



Fig. 5.1: Partial front view of Sunny Boy 2000 Description for the following text:

- ⊗ LED off
- ◐ LED blinks once per second
- ⊗ LED blinks fast (ca. three times per second)
- LED is constantly on
- not relevant





















LED-indicator		Operating Condition	Description
green:		standby (night)	input voltage < 60 V
red:			
yellow:			
green:		initialization	input voltage 60 V ... 120 V
red:			
yellow:			
green:		stop	changing operating condition or manually initiated condition
red:			
yellow:			
green:		waiting, checking grid	starting conditions are being checked
red:			
yellow:			
green:		feeding grid MPP or constant voltage mode	normal operation
red:			
yellow:			
green:		isolation failure	earth fault of the PV-panels or failure of surge voltage protection
red:			
yellow:			
green:		failure	internal or external failure, exact description depending on blink code
red:			
yellow:			

Table 5.1: Operation indication overview

Operation Indicator

Standby (night)

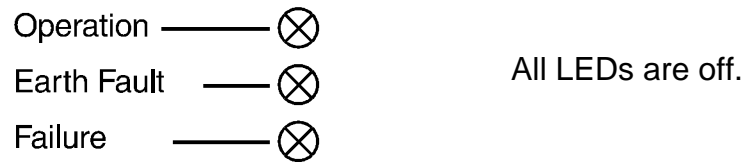

The Sunny Boy is in so called 'Stand by' mode. The input voltage is too low ($V_{pV} < \text{approx. } 60 \text{ V}$) to supply the inverter control system with enough power.

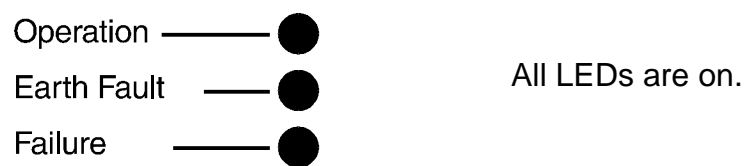

Initialization



The Sunny Boy control system is initializing.

The string voltage to the inverter is between approx. 60 and 120 V. The supply is sufficient for the system control and not quite sufficient for feeding to the grid. Data transmission is not possible yet.

Stop

Operation		Green LED blinking (approx. three times per second)
Earth Fault		Red LED off
Failure		Yellow LED off

The inverter has stopped operation, among other things the measurement electronics is calibrated. Subsequent condition is 'Waiting'.



'Stop' condition can also be initiated by the user with the Sunny Boy Control or the PC program Sunny Data. In this case the Sunny Boy inverter remains in this condition until set to 'MPP-Operation' or 'Constant Voltage Operation'.

Waiting, Grid Monitoring

Operation		Green LED blinking once a second
Earth Fault		Red LED off
Failure		Yellow LED off

The inverter is checking the grid concerning its suitability for feeding electricity (starting voltage, starting time) and begins to monitor the grid.

Operation

Operation		Green LED on
Earth Fault		Red LED off
Failure		Yellow LED off

The Sunny Boy has successfully completed self-testing its measurement electronics and MSD and starts feeding to the local electricity grid.

- **‘MPP’ mode (default setting):**

The Sunny Boy independently acquires the MPP voltage of the PV-panel which is internally defined as PV setpoint voltage.

In MPP mode the maximum power point P_{AC} is set by changing the required PV voltage at the PV-panel.

- **‘Constant Voltage’ mode:**

The voltage from the PV-modules can be manually set to a fixed value (“U.-Konst.”) defined by the operator via the Sunny Boy Control or with Sunny Data software. In the constant voltage mode the Sunny Boy uses an externally defined PV setpoint voltage as a default value for its internal control.

Earth Fault Indicator

Isolation failure, defective varistor

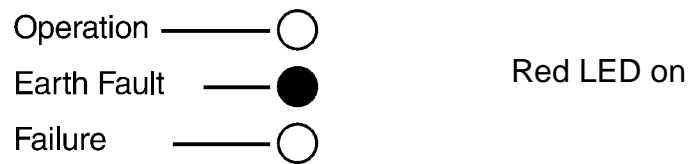

The inverter indicates an earth failure with the red LED. This condition can occur together with other conditions indicated by the LEDs.

The 'Earth Fault' indication can be based on two different conditions: Either the PV-panel connection has an isolation failure or at least one of the two thermally monitored varistors on the DC side are defective and therefore do not let any current pass.

The possible failures and methods to find out how to distinguish the reasons for the failure are described in the following.

- **Isolation failure**

An isolation failure has occurred at the PV-panel or its cabling. The plus or minus pole of the PV-panel or one of its modules has a connection ($< 2 \text{ M}\Omega$) to the grounding earth (PE).



Any isolation failure must always be removed by qualified personnel only.

A low resistance connection between the plus or minus pole and the grounding can lead to highly dangerous electric shocks even if only one pole is touched. Since the user himself normally is connected with the grounding he is highly in danger when touching any pole.

- **Failure of the thermally monitored varistors on DC-side**

On the DC input side the Sunny Boy is equipped with thermally monitored varistors (plus and minus pole to protective earth each). They are installed in order to prevent the inverter from being destroyed by atmospheric surge voltages (thunderstorm etc. invoked electric fields). If the thermally monitored varistors have triggered for several times (a thermally monitored varistor is the serial circuit of a varistor and a thermal fuse) they can get defective by not letting any current pass anymore and therefore not providing the intended safety. This condition is indicated with the 'Earth fault' LED.



It is highly recommended to have qualified personnel exchange the thermally monitored varistors if necessary.

- **Determining the Failure**

The red LED indicates one of the above mentioned failures. A short description on how to distinguish between these and conduct the appropriate countermeasures is given in the following.

This description is very concise – please stick to the relevant regulations in chapters 3.3, 'Electric Connection' and 4, 'Commissioning'.

- Disconnect the inverter from the grid (mains fuse).
- Disconnect the inverter from all poles of the PV-panel (snap cable connectors)



Wait for at least 30 minutes for the internal voltages to discharge!

- Open the inverter.
- Remove the two internal thermally monitored varistors (Fig. 5.2) with an appropriate screwdriver.
- Short circuit the connectors 2 and 3 in the connector blocks X2 and X3 (see Fig. 5.2).

- Reconnect the PV-panel, **do not connect the mains voltage!**
- If the red LED is off see 'A' - if the LED is on see 'B'.

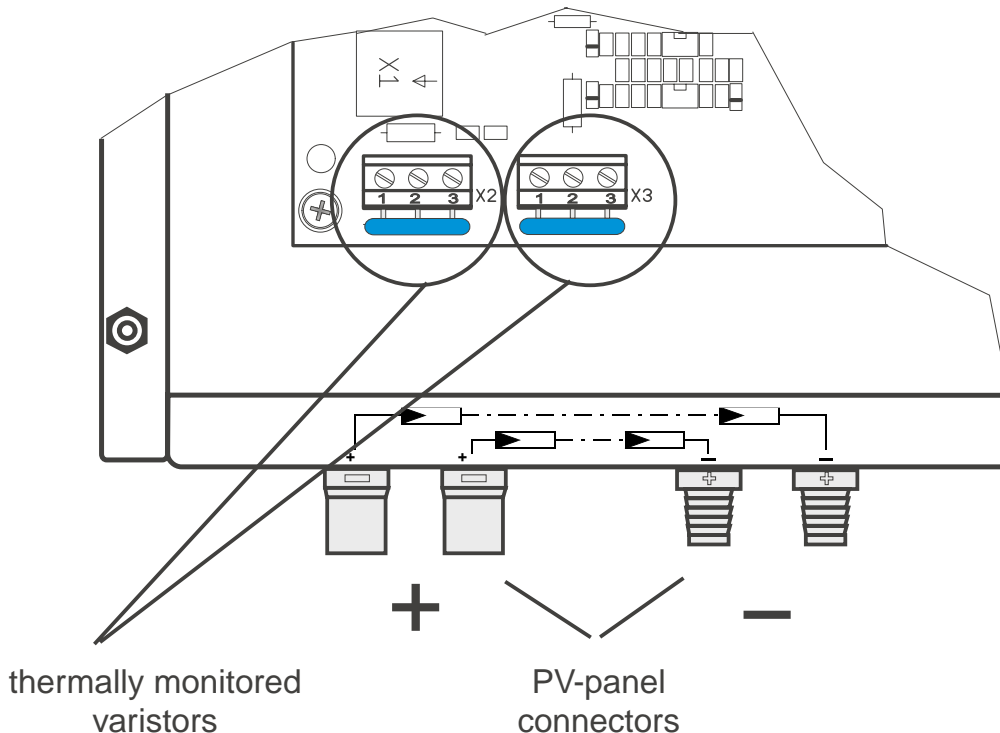

Fig. 5.2: Thermally monitored varistors

- A** The red LED is off.
At least one of the thermally monitored varistors is defective. We recommend to replace **both** varistors by original SMA spare parts.



The thermally monitored varistors are only available from the manufacturer because they are designed especially for the Sunny Boy inverter systems.

- B** The red LED is still on. The following must be done:

- disconnect all poles of the PV-panel from the inverter



Wait at least 30 minutes until all internal voltages have discharged!

- Remove the short circuits from 2 to 3 in the two connector blocks X2 and X3. Short circuit the connector 2 in connector block X2 to connector 2 in connector block X3.

- Re-connect the PV-panel to the inverter.
- If the red LED is still on the inverter is damaged and has to be repaired by the manufacturer.

If the LED is off the insulation of the inverter or the connection cabling is defective. The failure must be detected with appropriate measurements and then removed (see chapter 3.3.2, 'Connection of the PV-panels').

- Disconnect the inverter from the PV-panel.
- Seal the connectors with the caps.

Failure Indicator

Consistent Failure

Operation	———	⊗	
Earth Fault	———	⊗	
Failure	———	●	Yellow LED on

The yellow failure LED is permanently on.

This is a failure of the grid monitoring or the autonomous disconnection device MSD. In an internal test the inverter has detected a failure in the disconnection facilities and has suppressed grid feeding. Please see chapter 7, 'Troubleshooting' for further proceedings.

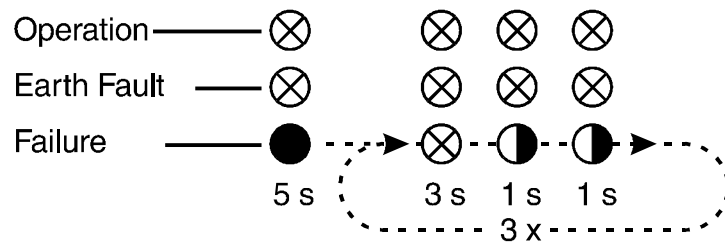
Blinking code 2: Grid Failure

The yellow failure indication LED is activated for 5 seconds, is out for 3 seconds and then blinks twice. The code is sent three times.

If the failure persists the indication blinking code is repeated.

The Sunny Boy is indicating a grid failure which has one of the following reasons:

- Low grid voltage ($< V_{AC\ min}$ see Table 9.1)
- High grid voltage ($> V_{AC\ max}$ see Table 9.1)
- Low grid frequency ($< f_{AC\ min}$ see Table 9.1)
- High grid frequency ($> f_{AC\ max}$ see Table 9.1)

Check the electric grid supply (check the function of other electric consumers) and check the fuse of the mains connector to the inverter.



If you do not detect any failure have the mains connection to the inverter checked by a qualified electrician.

This person should check the correct connection and the internal fuse (see Fig. 3.4 on page 23).



Disconnect the inverter before opening the device.

Blinking Code 3: Grid impedance too high

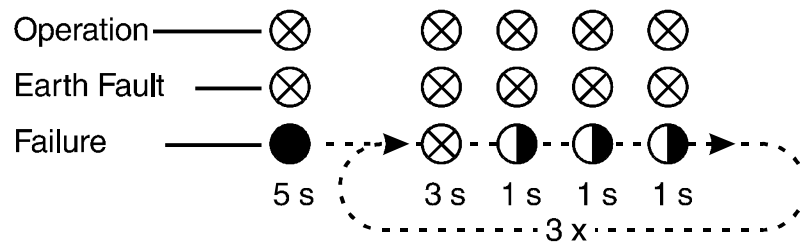

The yellow failure LED is activated for 5 seconds, remains dark for 3 seconds and then blinks three times. The code is sent three times.

If the failure persists the indication begins once again.

The inverter has detected a failure based on non-permissible grid impedance values. Criteria for grid impedance during connection and feeding are described in detail in paragraph “Autonomous Grid Disconnection Device” on page 13.

Should the inverter switch off very often during grid monitoring the grid impedance might be too high. The impedance can be checked with the Sunny Boy Control or Sunny Data. If the impedance exceeds $Z_{AC} \geq 1.25 \Omega$ the Sunny Boy may not conduct grid feeding. This failure can normally be avoided by increasing the thickness of the AC cabling.

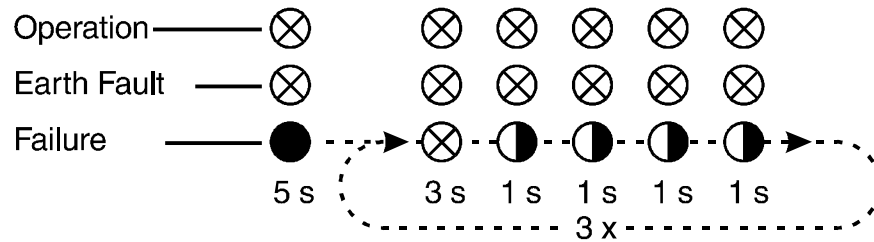
Blinking code 4: Input voltage (PV-panel) too high

The yellow failure indication LED is activated for 5 seconds, out for 3 seconds and then blinks four times. The code is sent three times.

If the failure persists the indication is repeated.

Input voltage is too high. The PV-panel is generating a voltage higher than the permissible 500 V!



Disconnect the PV-panel from the Sunny Boy immediately. Too high input voltage can cause a non-repairable damage!

Have the circuits of your PV-panel checked. Please see chapter 9, 'Technical Data' for the permissible PV input voltage.

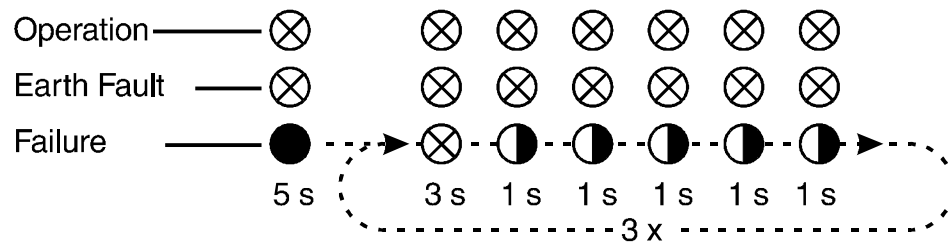
Blinking code 5: Device failure

The yellow failure indication LED is activated for 5 seconds, out for 3 seconds and then blinks five times. The code is sent three times.

If the failure persists the indication is repeated.

The device is in a condition that makes it impossible to return to normal operation.
The device is most likely defective.



The inverter has to be checked by a qualified technician.

Blinking code 6: Discharge Current too high

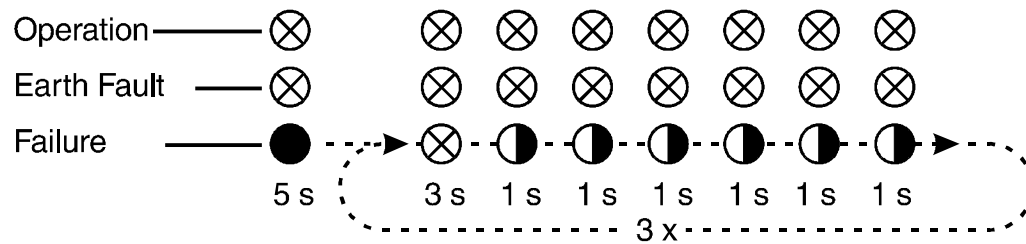

The yellow failure indication LED is activated for 5 seconds, out for 3 seconds and then blinks six times. The code is sent three times.

If the failure persists the indication is repeated.

The discharge current between the inverter and the PV-panel exceeds 95 mA. The inverter stops feeding to the grid immediately after the current goes beyond the above mentioned threshold and restarts normal operation after a short while.

The discharge voltage depends on the PV panel's capacity to the grounding as well as on the kind of mounting and type of modules. A temporary variation is therefore normal.

Have the system checked by an electrician if this failure occurs very often.

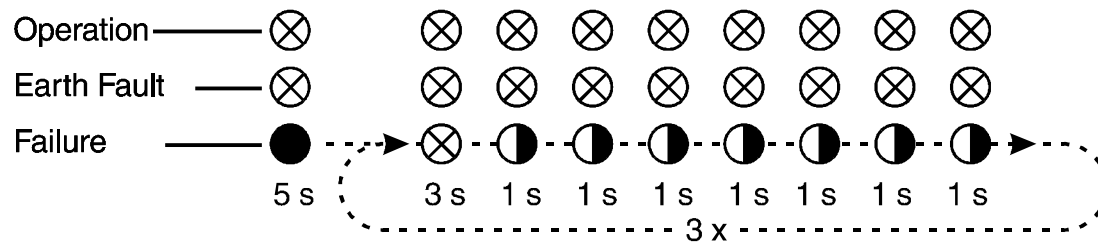
Blinking code 7: Drastic Differential Current change

The yellow failure indication LED is activated for 5 seconds, out for 3 seconds and then blinks seven times. The code is sent three times.

If the failure persists the indication is repeated.

The Sunny Boy's monitoring systems have detected a differential current and immediately disconnected the device from the grid. The integrated all-pole sensitive differential current control monitors the discharge current between the AC output of the inverter and the PV-panel. This additional safety feature is triggered by drastic changes of the differential current of $I_{\Delta N} \geq 30 \text{ mA}$ and disconnects the inverter from the grid within 0.2 seconds.

6 Plant Monitoring and Diagnosis

6.1 Data Transmission via Powerline

Signal transmission between the Sunny Boy and the Sunny Boy Control or the PC is done with the grid connection via Powerline. This requires a minimum of installation (see Fig. 6.1: Example of data transmission via Powerline'). The Sunny Boy must be equipped with a Powerline modem for data transmission. The PC must be equipped with the socket modem (SWR-COM). This is already integrated in the Sunny Boy Control, the specific controller for PV-plants. The PC or the Sunny Boy Control can be positioned anywhere within the in-house network as they acquire data directly from the AC circuit.

For trouble-free operation the Sunny Boys and the PC socket modem or the Sunny Boy Control must be connected to the same phase of the in-house network. If the communicating partners are connected to different phases the communication must be established with a so-called phase coupling device. The phase coupling device is available from SMA and must be installed by qualified personnel. It will make communication within the entire in-house network possible.

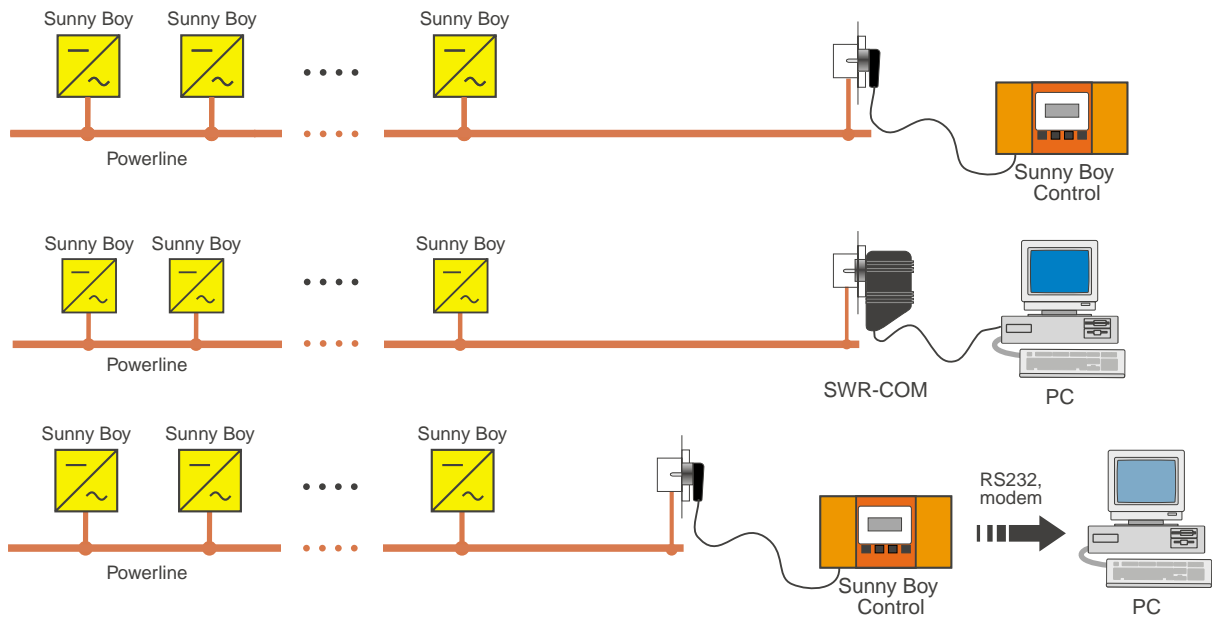

Fig. 6.1: Example of data transmission via Powerline

A detailed description of this data transmission called “Technical Description of Powerline Communication” is available from SMA.

What do you need for Powerline communication?

- The Sunny Boy must be suitable for Powerline communication (order no.: SWRxxxx-NE:1x0). I.e.:
 - The Powerline piggy back modem is installed (see Fig. 6.6).
 - The last digit of the system control software version is a two (VX.x2).
 - The blue resistors under the piggy back have to be installed for Powerline communication (see Fig. 6.6, page 59).
- For communication with the PC
 - A socket modem SWR-COM is available.
 - Some PCs are equipped with a 25-pole DSUB plug connector (e.g. COM2) in terface. Then an RS232 adapter 25-pin (plug) to 9-pin (socket) is necessary (order no. 36-5010).
 - The visualization software Sunny Data must be installed.

How to install Powerline Communication

- Powerline Communication with a PC
The RS232 connector from the SWR-COM is plugged into a free COM port of the PC (COM1 ... COM4). If necessary use the interface adapter DB9/DB25. The SWR-COM is plugged into the electricity socket. For details on the visualization software Sunny Data please see the Sunny Data manual.
- Powerline Communication with a Sunny Boy Control
Plug the 230V power cable of the Sunny Boy Control into the electricity socket. For operation of the Sunny Boy Control or Sunny Data Control for Sunny Boy Control please refer to the according manuals.

6.2 Data Transmission with a Separate Data Cable

Data transmission via Powerline is a reliable and affordable solution. In electrical grids which are strongly influenced by high-frequency disturbance such as those in industrial sites data transmission via Powerline may not be possible. Communication between the Sunny Boys and the Sunny Boy Control or the PC can then be done with a separate data cable.

RS232 communication

If only one Sunny Boy has to be connected to the PC the easiest way is direct coupling via an RS232 port. A maximum of 15 m is permissible between the PC and the Sunny Boy.

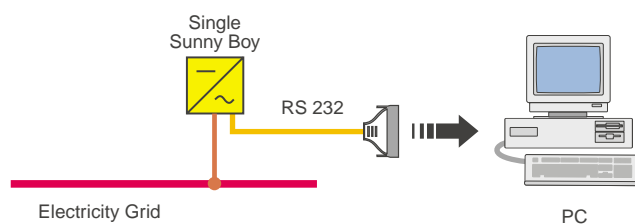

Fig. 6.2: Data transmission with a separate data cable to one single Sunny Boy



RS232 communication with one Sunny Boy is only a reasonable solution with direct connection to the PC.

If a Sunny Boy Control is used instead of the PC an RS485 connection is necessary even for communication with only one Sunny Boy (see section ‘RS485 communication’ for details).

What do you need for RS232 communication?

- a special RS232 piggy back module for the Sunny Boy
- the last digit of the system control software version is a two (VX.x2).
- the visualization software Sunny Data is installed on the PC
- the light blue resistors (Fig. 6.3) on the system control board are **removed**.
- Some PCs are equipped with a 25-pin DSUB plug connector. In this case an RS232 adapter 25-pin (plug) to 9-pin (socket) adapter is necessary (order no. 36-5010).

Installation of the RS232 cable



Work on the inverter may only be carried out if the device has been disconnected and discharged! (See also chapter 3: 'Installation')

- Connect RS232 connection cable LIYCY; 0.25 mm², minimum three-cable with common shield and a maximum length of 15 m. You can see the connector layout in Fig. 6.2.1. The shielding should be connected to protective earth (PE) on both ends at the Sunny Boy and the PC case.

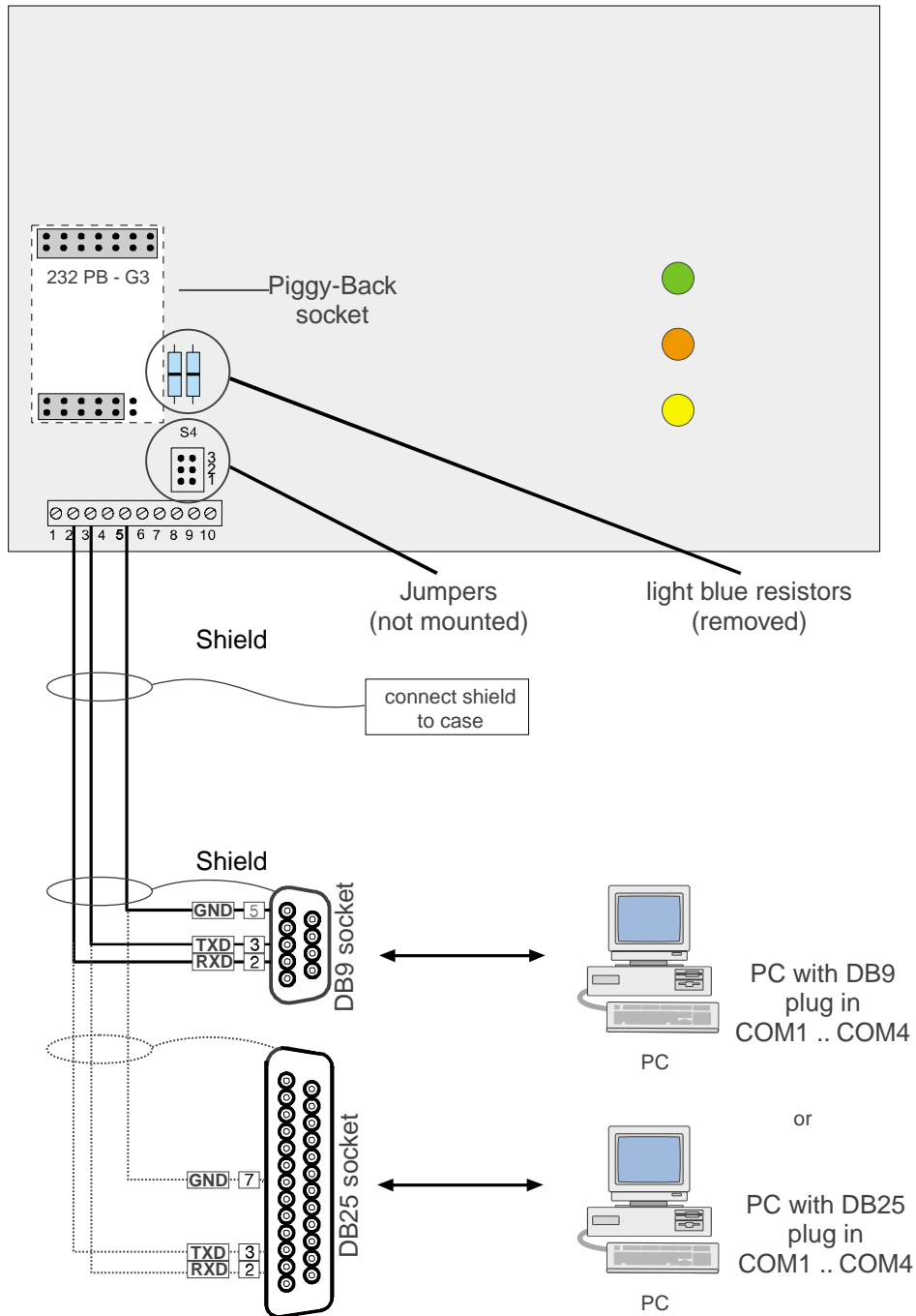

Fig. 6.3: System control board Sunny Boy with RS232 cabling

RS485 communication

In grids loaded with high interference several Sunny Boys can be connected to a PC or the Sunny Boy Control via RS485 and a separate data cable. Data cables of up to 1200 m are permissible.

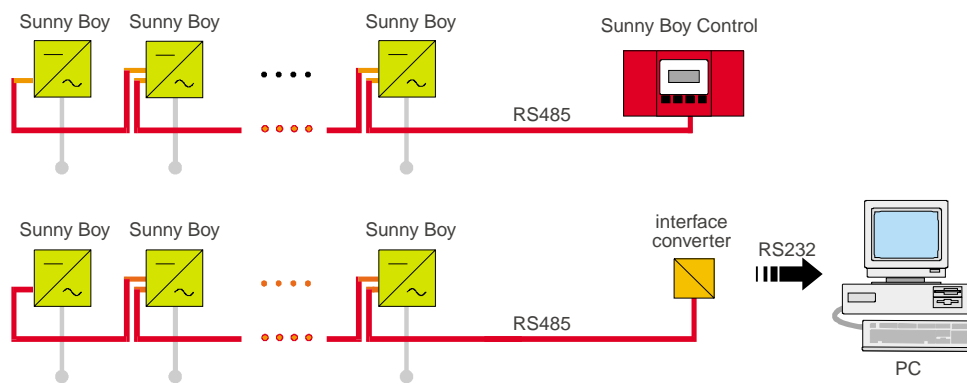

Fig. 6.4: Schematic layout of RS485 data transmission with several Sunny Boys

What do you need for RS485 communication?

- a special RS485 piggy back module has been installed in all Sunny Boys
- the last digit of the system control software version is a two (VX.x2)
- the light blue resistors on the system control board are **removed**
- if connected to a PC:
 - The interface converter RSU485 (ordering no. 39-0020) is available.
 - Sunny Data visualization software is installed on the PC.
 - Some PCs have a 25-pin COM port. However, the cable supports a 9-pin COM port. In this case a small adapter (ordering no. 39-5010) is necessary.

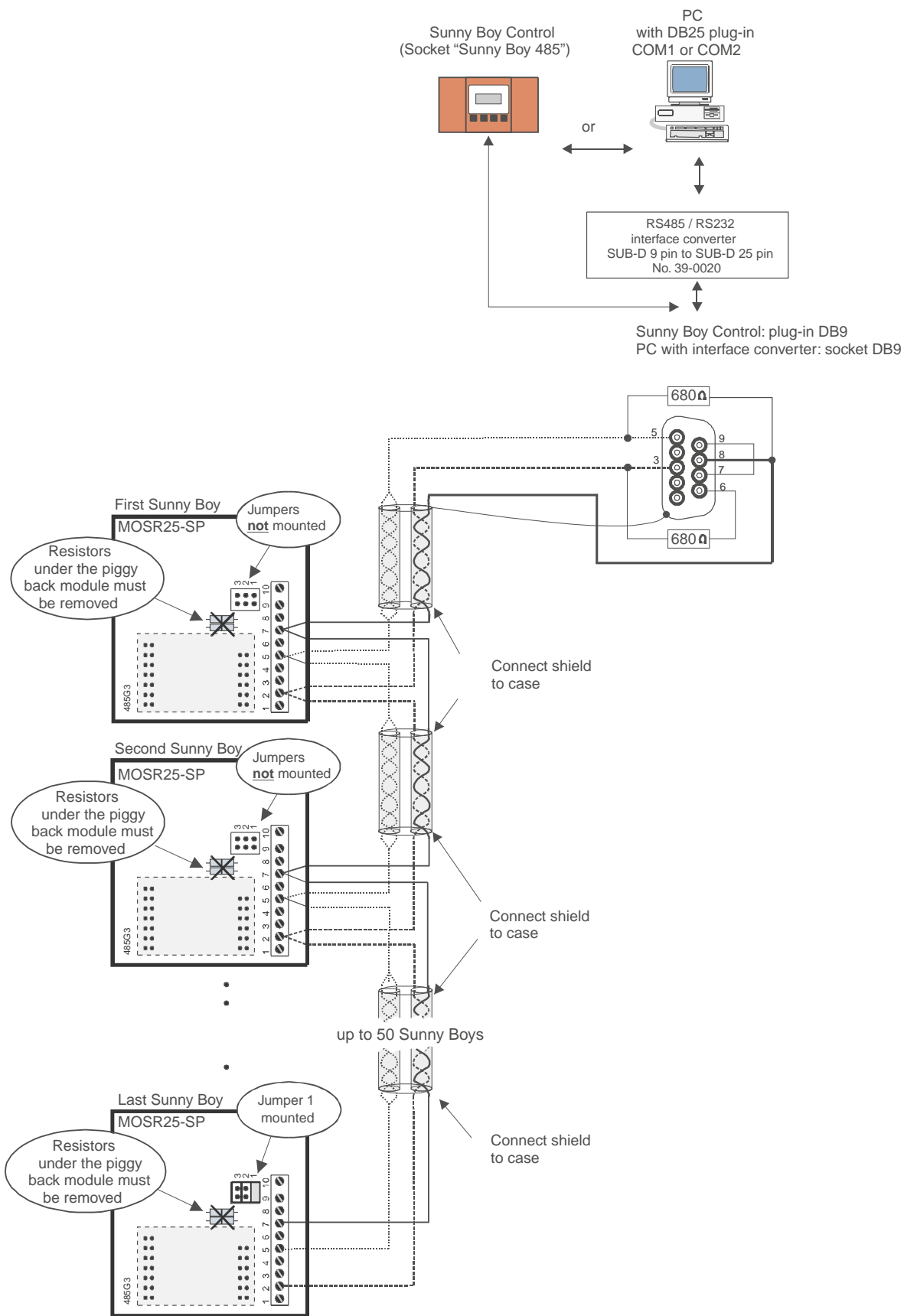

Fig. 6.5: System control board Sunny Boy with RS485 cabling

Installation of the RS485 cable



Work on the inverter may only be carried out if the device has been disconnected and discharged! (See also chapter 3: 'Installation')

- Connect pin 7 and pin 9 on the end of the cable that is connected to the interface converter.
- If you are using a PC instead of a Sunny Boy Control, switch the interface converter RS485/RS232 (ordering no. 39-0020) to "DTE".
- The transmission cable is terminated on the **last** Sunny Boy on the cable. There a termination resistor is connected by mounting a jumper (no. 1, jumper directly above the terminal strip).
- Two resistors of 680 Ohm each must be integrated into the DB9 connection at the beginning of the cable that is connected to the Sunny Boy Control or the PC. One is soldered from pin 3 to pin 6, the other is soldered from pin 5 to pin 8.
- For the RS485 connection we recommend an LIYCY 2 x 0.25 mm twisted pair cable with a maximum length of 1200 m (4000 ft). It consists of four data lines two of which are combined respectively to form altogether two twisted pairs surrounded by a single common shield which must be connected to protective earth (PE) on both ends.
- If necessary an adapter for the RS232 plug from the interface converter to the PC (9-pin plug to 25-pin socket)

9-pin to 25-pin adapter

DB9	DB25	description
1	8	DCD (Data Carrier Detect)
2	3	RX (Receive Data)
3	2	TX (Transmit Data)
4	20	DTR (Data Terminal Ready)
5	7	GND (Signal Ground)
6	6	DSR (Data Set Ready)
7	4	RTS (Request To Send)
8	5	CTS (Clear To Send)
9	22	RI (Ring Indicator)

Table 6.1: Pin designation of the DB9/DB25 adapter

6.2.1 Upgrading or modification of the Sunny Boy interface

The Sunny Boy is prepared for data transmission. By simply plugging on a piggy back module it supports the RS232 or RS485 interfaces or the Powerline protocol.

In order to install a new interface in the Sunny Boy a corresponding piggy back module has to be installed on the system control board. Please follow all relevant instructions in chapters 3.3: 'Electric Connection' and 4: 'Commissioning'.



The Sunny Boy works with high voltages externally and internally which can cause considerable harm to people. Only a qualified electrician may work on the device, especially open it!

While upgrading the Sunny Boy interface the operator can get into touch both with electronic components and components carrying lethal voltage. Faulty upgrading can lead to damage at the device and danger to people by electric voltage.

Therefore the device may only be upgraded by qualified personnel or the SMA service.



Only work on the Sunny Boy when it is disconnected from the grid and sufficiently discharged!

Follow ESD protection countermeasures when modifying the Sunny Boy:

Electronic components are sensitive to electrostatic discharge. To protect them you have to be on the same electric potential. Discharge the electrostatic charge by touching the grounded case before touching an electronic component, otherwise you run a great risk of destroying your electronics.

Work on the inverter always has to be done in the order described:

1. Disconnect the inverter from the grid.
2. Disconnect the inverter from all poles of the PV-panel.



Wait for approximately 30 minutes until internal voltages have discharged.

Open the device only after the above steps have been taken.

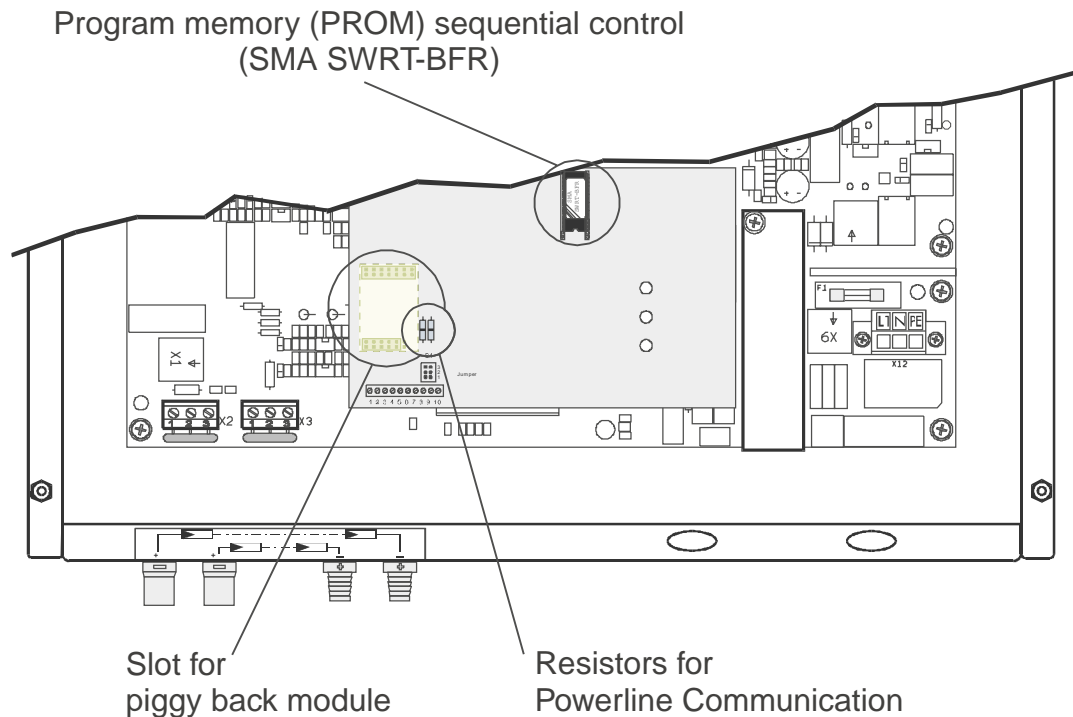

Fig. 6.6: Sunny Boy 2000 sequential control board

- Remove any piggy back that might be installed on the system control board.
 - Only for installation of an RS232 or RS485 board:
 - Remove the light blue resistors that might be installed on the system control board by cutting them out with a wire cutter.
 - Only for installation of a board for Powerline Communication:
 - Please make sure that the light blue resistors are plugged onto the system control board. If not, bridges (corresponding to 0 Ω resistors) have to be installed in there.
- Plug the desired piggy back module onto the required slot. When plugging on the piggy back please make sure no socket of the piggy back plug-in contacts remains open.

- Connect the green-yellow PE cable to the lid and close the Sunny Boy with the lid. Tighten all four screws.
- Reconnect the PV-panel.
- Connect the inverter to the grid.

If enough PV-power is supplied the inverter automatically starts feeding to the grid.

6.3 Graphic User Interface under Windows

Sunny Data

Sunny Data is used in order to establish a communication between a PC and your Sunny Boys and process and evaluate data from these. It provides a graphic user interface with all positive features known under Windows.

The available measurement channels of the Sunny Boy (see chapter 6.4: 'Measuring Channels and Messages of the Sunny Boy') can be displayed online. The data can be displayed manually or automatically and is stored in files on any available storage medium. Special functions allow the installer to modify the operating parameters of the Sunny Boy in order to improve system performance. Please see the Sunny Data manual for further information on Sunny Data.

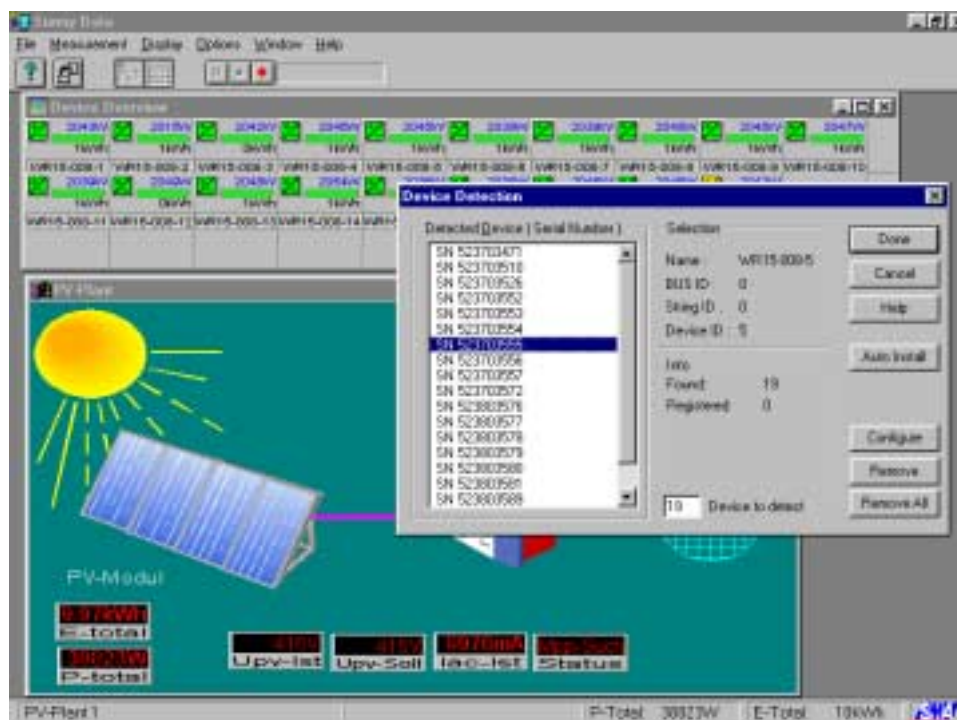

Fig. 6.7: Sunny Data user interface

Sunny Data Control

Large PV-plants with numerous Sunny Boys are supervised and monitored with a Sunny Boy Control. The Sunny Boy Control handles central measurement data acquisition and diagnosis for up to 50 Sunny Boys and assists the commissioning of the PV-plant. Additional features are remote diagnosis via modem and fax messages.

For global visualization of PV plant data SMA offers the Sunny Data Control PC software under Windows. E.g. the power output of the entire large-scale PV-plant can be shown in a matrix. For the numerous possibilities of establishing a monitoring concept with Sunny Boy Control please see the Sunny Boy Control manual.

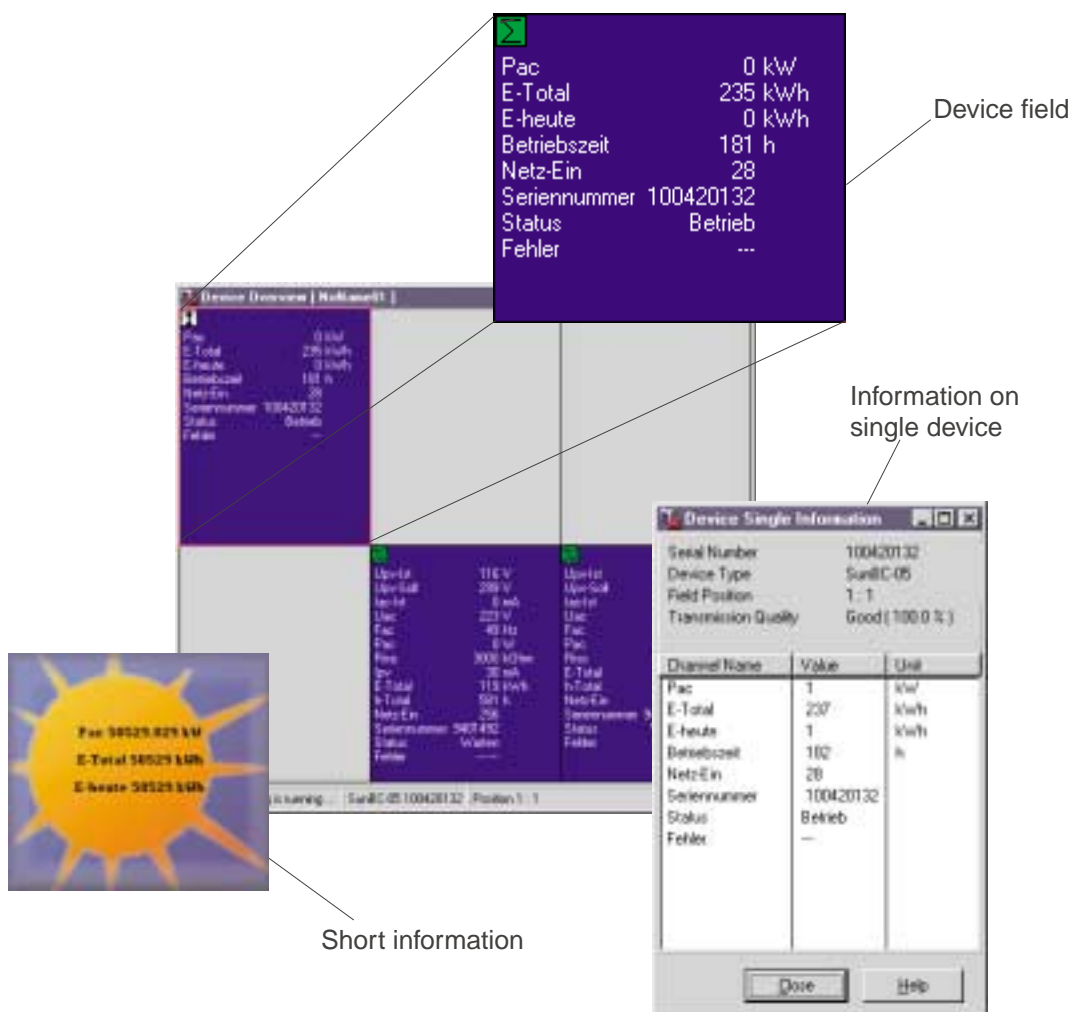

Fig. 6.8: Sunny Data Control graphic user interface

6.4 Measuring Channels and Messages of the Sunny Boy

If your PC is equipped with communication (see chapter 2.2: 'Diagnosis and Communication'), it supports a number of measuring channels and messages from the Sunny Boy inverters and transmits them to the output unit for diagnosis.

The following abbreviations are used:

BFR	B etriebsf <u>ü</u> hrungsrechner (Sequential Control System)
SRR	S tromregelungsrechner (Current Control System)

Measuring Channels

Upv-Ist	PV-input voltage
Upv-Soll	PV-desired voltage of the internal Upv-control
Iac-Ist	current to the grid
Uac	grid voltage
Fac	grid frequency
Pac	power fed to grid
Zac	grid impedance
Rerd-Start	isolation resistance of PV-plant before connected to the grid
I _{pv}	current from PV-panel
dI	discharge current of PV-plant (inverter and PV-panel)
E-Total	total energy fed to the grid
h-Total	total operation hours
Netz-Ein	number of times the inverter starts feeding to the grid
Seriennummer	Sunny Boy serial number
Status	current status
Fehler	failure description for status 'failure'

Status Messages

Stop 1	manual system stop
Offset	offset calibration of the electronics
Warten	waiting: starting conditions not fulfilled (yet) ($U_{PV} < U_{PV} \text{ start}$)
Netzueb.	checking grid (grid impedance)
Zuschalt	electronics are connecting to grid

MPP-Such	PV setpoint voltage is determined and set
MPP	Sunny Boy is in MPP mode
U-Konst.	Sunny Boy is in constant voltage mode
Stoer.	failure

Error messages

Bfr-Srr	communication between microcontrollers is failing
EEPROM	EEPROM cannot be read or written in
Fac-Bfr	BFR-frequency measurement - value out of tolerable range
Fac-Srr	SSR-frequency measurement - value out of tolerable range
DI	BFR-sudden change of differential current, value out of tolerable range (30 mA/s)
dl-Srr	SRR-sudden change of differential current leap, value out of tolerable range (30 mA/s)
dl-Mess	Acquisition of differential or fault current defective
dZac-Bfr	BFR-sudden change of impedance - value out of tolerable range
dZac-Srr	SSR-sudden change of impedance - value out of tolerable range
Imax	internal overcurrent
K1-Schliess	Relay K1 does not close correctly
K1-Trenn	Relay K1 does not separate correctly
K2-Trenn	Relay K2 does not separate correctly
NUW-UAC	different values between BFR and SRR for grid voltage
NUW-dI	different values between BFR and SRR for differential current
NUW-FAC	different values between BFR and SRR for grid frequency
NUW-Mess	different values between BFR and SRR for dI, Fac, Uac or Zac
NUW-REL	Relay test failed
NUW-ZAC	different values between BFR and SRR for grid impedance
Offset	Offset check for grid voltage measurement failed
Rechner	BFR or SSR controller failure
Riso	isolation resistance out of tolerable range
Uac-Bfr	BFR-grid voltage measurement - value out of tolerable range
Uac-Srr	SSR-grid voltage measurement - value out of tolerable range
UpvMax	PV input voltage above the tolerable maximum value
Uzwk	Internal voltage out of tolerable range
Zac-Bfr	BFR-grid impedance measurement - value out of tolerable range
Zac-Srr	SSR-grid impedance measurement - value out of tolerable range
Watchdog	Watchdog for operation control triggered

6.5 Measurement Precision

Any kind of measurement is inaccurate to a certain degree. Measurements taken by the Sunny Boy are required for its operational control and the control unit of current to be fed to the grid. The reproducibility of measurement values complies with these requirements. A maximum measurement error is conceived for an ambient temperature ϑ_U of 25 °C. Other temperatures must be evaluated with respect to the inaccuracy resulting from these different temperatures.

	[Unit]	Range	Resolution		Max. fail. $\vartheta_U=+25^{\circ}\text{C}$
			Display	Measurement	
input voltage	U_{PV} [V]	0...561 V	1 V	0.55 V	$\pm 2\%$
input current	I_{PV} [mA]	0...10000 mA	1 mA	10 mA	$\pm 4\%$
grid voltage	U_{AC} [V]	190...300 V	1 V	0.3 V	$\pm 1\%$
grid current	I_{AC} [mA]	0...12,490 mA	1 mA	12 mA	$\pm 2\%$
grid frequency	f_{AC} [Hz]	45...55 Hz	0.01 Hz	0.01 Hz	$\pm 0.1\%$
output power	P_{AC} [W]	0...3200 W	1 W	1 W	$\pm 3\%$
energy yield	E [kWh]	0...4.29*10 ⁹ Wmin	1 Wmin	10 Wmin	$\pm 3\%$
operating hours	h [h]	0...4.29*10 ⁹ s	1 s	0.67 μs	$\pm 0.1\%$

Table 6.2: Measurement accuracy of the Sunny Boy

7 Troubleshooting

Our quality management strategy includes a constant quality improvement of our products. We always are concerned to avoid all failures and malfunctions of our products.

The product you purchased was shipped in impeccable condition after successfully passing numerous tests concerning the operation behavior, the disconnection devices and a long term heavy duty tests.

We recommend to conduct the following steps in case your PV-plant nonetheless does not operate correctly:

- Check the blink code on the lid of the Sunny Boy and compare the code with the blink codes listed in chapter 5. Follow the countermeasures listed there, if necessary contact the installer.
- Check the “Status“ and “Failure“ messages in one of the monitoring systems described in chapter 6: ‘Plant Monitoring and Diagnosis’ if present.
- Contact the Sunny Boy service if the system malfunction persists. The address is listed in the appendix.

In order to let your PV-plant operate again as soon as possible it is essential to provide the following information:

- **Information concerning the Sunny Boy**

- type of Sunny Boy
- serial number of the inverter
- short failure description
 - Number of the blink code
(see chapter 5: 'Operation and Failure Indication LEDs')
 - If Sunny Boy Control or a PC with Sunny Data is present:
Which status and failure are indicated?
 - Can you reproduce the failure?
If so, how can you reproduce it?
 - Does the failure occur sporadically?
 - Has this failure always occurred?
 - What were the ambient conditions when the failure occurred?

- **Information concerning the PV-modules**

- type of modules, supplier
- number of modules per string, number of strings
- output power
- open circuit voltage

Use the original box the Sunny Boy was delivered in if the inverter has to be returned to the manufacturer in order to protect it against damage during transport. SMA cannot provide warranty for damages resulting directly or indirectly from inappropriate transport packaging.

8 Warranty Regulations and Liability

You have purchased a product which was thoroughly checked before delivery. Should your device nonetheless be defective or show a malfunction during the warranty period please contact your distributor or installer.

Warranty

The warranty period is **24 months** from the date the end user purchases the device. It ends at the latest 30 months after the date the device left the SMA production site and includes all defects caused by material or manufacturing faults.

The warranty period for guaranty repairs or substitution deliveries ends 12 months after delivery, but runs at least until the expiration of the original warranty period for the item delivered.

Evidence

SMA will only render guaranty services if the objected device is sent back to SMA together with a copy of the invoice the distributor made out to the consumer. The type plate at the device must be completely legible. In case of non-fulfillment SMA reserves the right to refuse guaranty services.

Conditions

It is in SMA's discretion whether the device will be repaired in its works without invoicing material and work cost or a replacement device will be delivered.

The objected device is to be sent back to SMA free of charge in the original packaging or in a transport packaging of equal quality. If the warranty applies transport costs will be for SMA's account.

The customer has to grant SMA the necessary time and opportunity to repair the defects.

Exclusion of Liability

Excluded are any guaranty claims and liabilities for direct or consequential damages due to

- transportation damages,
- faulty installation or commissioning,
- manipulation, alterations or repairing attempts,
- inappropriate use or operation,
- insufficient air supply to the device,
- non-respect of relevant safety regulations (VDE etc.), or
- force majeure (lightning, surge voltage, storm, fire).

We cannot guarantee the proper function of data transmission via mains lead (power line modem) in case it is carried out in electric grids with high harmonic distortion or high-frequency line distortions e.g. in industrial power supply grids or in the neighborhood of irregular consumers (unshielded motors, switching power supplies, converters, etc.). Furthermore, the simultaneous operation of babyphones may lead to short-time data transmission disturbances or interruptions. In case of disturbed data transmission via mains lead we alternatively offer communication via separate data line as an option (RS232 or RS485, see chapter 6).

We do not guarantee that the software is completely free of faults. In case of a fault, an instruction how to avoid the effects of the fault is also considered as sufficient repair. Only the customer is responsible for the correct selection, orderly use, supervision and the consequences of the use of software.

We reserve the right to make alterations for improvement of the device.

Further or other claims for direct or indirect damages, especially including claims for damages from positive contract violation, are excluded insofar as not otherwise compelling stated by law.

9 Technical Data

Input Values (PV-panel)



When determining how many PV-modules are connected in series the operator has to make sure that the output voltage of the PV-panel is within the permissible input voltage range of the inverter even in case of extreme outside temperatures. In Central Europe one should expect module temperatures between -10°C and $+70^{\circ}\text{C}$.

- $U_0 (-10^{\circ}\text{C}) < \text{max. input voltage}$

The open-circuit voltage of the connected string has to be within the specified input voltage range even in case of very low outside temperatures (-10°C).

- $U_{\text{MPP}} (+70^{\circ}\text{C}) > \text{min. input voltage}$

The MPP voltage of the connected string must not exceed the specified input voltage range even in case of very high outside temperatures.



The inverter tolerates currents higher than the specified input voltage as long as the input voltage is within the specified range.

Input voltage:	V_{PV}	125 - 500 V DC
Max. input current:	I_{PV}	10 A DC
Max. input power:	P_{PV}	2100 W DC
Recommended max. PV-panel power:		2600 Wp
Voltage ripple:	U_{PP}	< 10%
All-pole disconnection on DC input side:		MultiContact [®] snap connectors ³

³ MultiContact[®] is a registered trademark of company Multi-Contact.

Surge voltage protection	thermally monitored varistors
Pole interchange protection	yes, by short-circuit diode
Personnel safety	Isolation monitoring and all-pole sensitive fault current monitoring system ($R_{ISO} > 2 \text{ M}\Omega$; $I_{\Delta N} \geq 30 \text{ mA}$)

Output Values (mains connection)

Nominal output power	P_{ACnom}	1800 W AC
Maximum output power	P_{ACmax}	2000 W AC
Output voltage range	V_{AC}	180 - 260 V AC
Output frequency range	f_{AC}	48 - 52 Hz
Total harmonic distortion of output current :	K_{IAC}	< 4 % (for $K_{UAC} < 2 \%$, $P_{AC} > 0.5 P_{ACnom}$)

Phase shifting factor

(related to fundamental): φ 0°

Grid monitoring

V_{grid} ; f_{grid} ; ΔZ_{grid} ; R_{ISO} ; $\Delta I_{\Delta N}$

MSD (Mains monitoring with allocated
Switching Devices) acc. DIN VDE 0126/ VDEW

All-pole disconnection grid-side: Independent disconnection device (MSD),
double

Short circuit proof: current controlled

Surge voltage protection: III

Insulation test voltage (50 Hz): 1.35 kV (1/5 s piece/type test)

Surge voltage test (1.2/50 μ s): 4 kV (serial interface: 6 kV)

External interfaces

Data transmission via Powerline: optional

Data transmission via data cable: optional; electrically separated; RS232 / RS485

Internal Power Consumption

In operation: < 7 W

In standby (e.g. at night) < 0.1 W

Efficiency

Max. efficiency η_{\max} > 96 %

Ambient conditions

Ambient temperature (permissible): -25°C ... + 60°C

Rel. air humidity 0 ... 100%, class 3K6

Mechanical values

Protection class I (basic insulation + PE connection)

Protection classification EN 60529: IP65 (dust-proof, jet-proof)

Size (width x height x back-to-front) ca. 434 x 295 x 214 mm

Weight ca. 24 kg

Certification

EMC: DIN EN 50081, part 1
(EN 55014, EN 60555 part 2,
EN 55011 group 1, class B)

DIN EN 50082, part 1

Grid interference: DIN EN 61000-3-2

Grid monitoring: independent disconnection device
(MSD) according to VDEW;
EN DIN VDE 0126 (10.97)

Low voltage regulation: DIN EN 50178 (4.98) (VDE 0160)
DIN EN 60146 part 1-1 (3.94)
(VDE 0558 part 11)

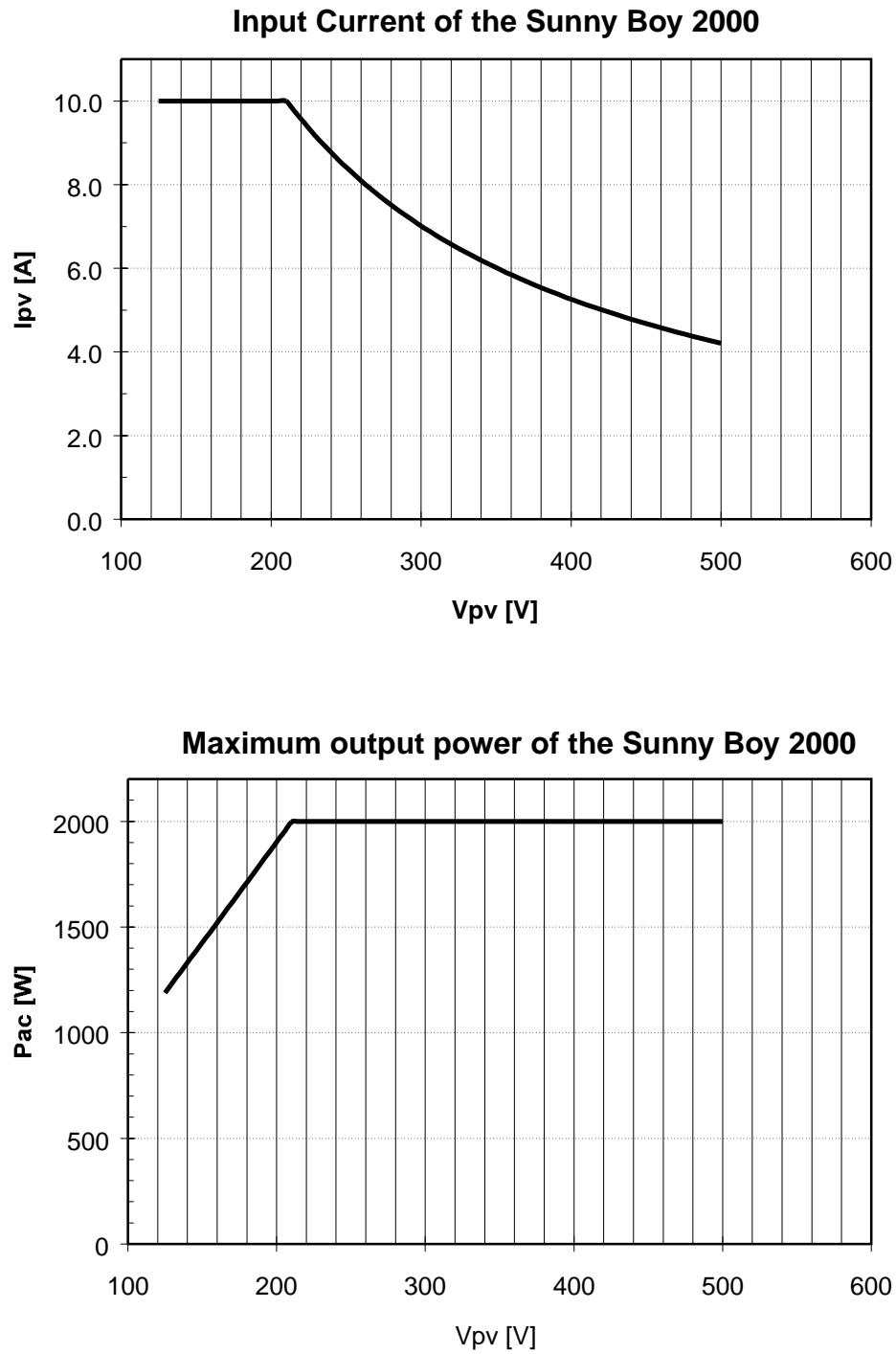

Fig. 9.1: Output Power P_{AC} and Input Current I_{PV} depending on Input Voltage U_{PV}

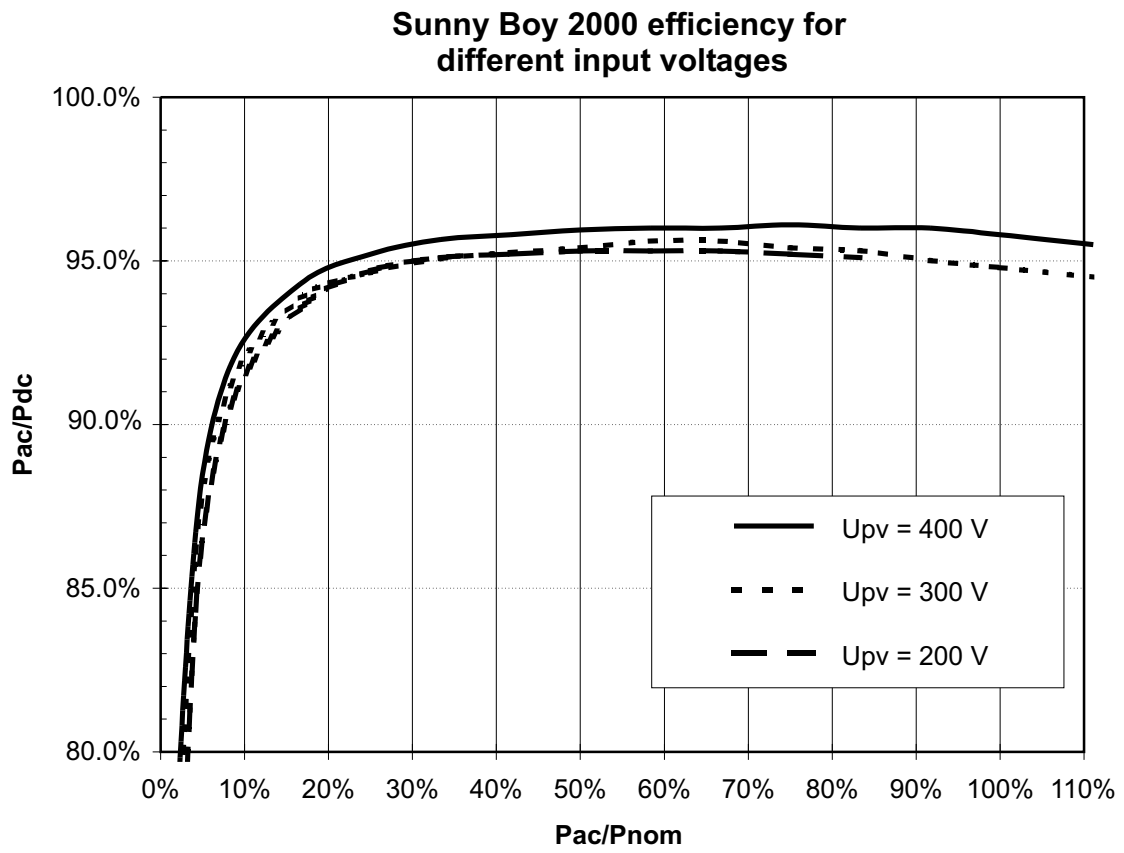

Fig. 9.2: Sunny Boy 2000 efficiency curve

Parameter List Sunny Boy 2000

All parameters are transmitted to Sunny Data or Sunny Boy Control when configuring the Sunny Boy 2000. The following table lists the parameters which can be displayed and changed:

No.	Name	Unit	Valid Range		Default Value	Changeable by
			From...	to...		
1	SMA-SN	-				Fixed
2	U _{PV} -Start	V	140	500	150	Installer
3	T-Start	S	5	300	10	Installer
4	U _{PV} -Stop	V	100	500	110	Installer
5	T-Stop	S	1	300	2	Installer
6	Usoll-Konst	V	140	500	450	Installer
23	NiTest		0	1	1	Installer
28	Uac-Min	V	180	300	198	Installer
29	Uac-Max	V	180	300	251	Installer
30	Fac-Min	Hz	49	51	49.81	Installer
31	Fac-Max	Hz	49	51	50.19	Installer
32	Zac-Max	mΩ	0	20000	1700	Installer
33	DZac	mΩ	0	2000	350	Installer
43	Hardware-BFS	Version				fixed
44	Software-BFR	Version				fixed
45	Software-SRR	Version				fixed
68	Operation mode				MPP-Operation	Installer
69	Storage function				none	Installer

Table 9.1: Sunny Boy 2000 Parameter List

We reserve the right to perform technical changes for improvement of the device.

10 Appendices

Appendix 1: Certificates for the Sunny Boy 2000

- SMA Declaration of Conformity
- Clean Report of Findings by the employee association



SMA Regelsysteme GmbH · Hannoversche Straße 1-5 · D-34266 Niestetal

SMA Regelsysteme GmbH
Hannoversche Straße 1-5
D-34266 Niestetal
Telefon (05 61) 95 22-0
Telefax (05 61) 95 22 100

Ihr Zeichen

Unser Zeichen
/

Bearbeiter

Telefon-Durchwahl
(05 61) 95 22-

Datum
03.05.99

Declaration of Conformity for the PV-inverter SWR 2000, Sunny Boy

We declare that the PV-inverter SWR 2000 complies with the VDE regulations for parallel grid feeding, especially the "Richtlinie für den Parallelbetrieb von Photovoltaik-Eigenerzeugungsanlagen mit dem Niederspannungsnetz" (Regulation for the parallel operation of photovoltaic-electricity facilities with the low voltage electricity supply grid) of the VDEW.

The SWR 2000 complies with the latest regulations concerning the redundant grid monitoring with allocated switching devices (English: *MSD i.e. Mains monitoring with allocated switching devices* German: *ENS i.e. Einrichtung zur Netzüberwachung mit jeweils zugehörigem Schaltorgan*) as issued by the council for electronics, the central organization for accident avoidance and industrial medicine of the main organization of the employee associations mainly the employee association of the precision mechanics and electric engineering and issued on the 7th of July 1994 together with the organization of German electricity producers (VDEW).

The SWR 2000 complies with the according regulations of the European Community, especially with those concerning EMC/EMI in accordance with 89/336/EWG and the low voltage regulation in accordance with 73/23/EWG. The inverter is marked with a CE sign.

The following regulations are furthermore complied with:

DIN EN 50081, Part 1
with EN 60555 Part, EN 55014, EN 55011 Group 1
Class B

and the

DIN EN 50082, Part 1
DIN EN 50178 (04.98) (VDE 0160)
DIN EN 60146, Part 1-1 (03.94) (VDE0558-Part 11)
E DIN VDE 0126 (10.97).

SMA Regelsysteme GmbH

G. Cramer

Geschäftsführer:
Dipl.-Ing. Günther Cramer
Dipl.-Ing. Peter Drews
Dipl.-Ing. Reiner Wetlaufer

Amtsgericht Kassel
HRB 3972
UST ID: DE 113085954

Commerzbank Kassel
(BLZ 520 400 21)
Kto 264 201 500
SWIFT: COBA DE FF520

Deutsche Bank Kassel
(BLZ 520 700 12)
Kto 041 8004

Kasseler Sparkasse
(BLZ 520 503 53)
Kto 132 994

Landeskreditkasse Kassel
(BLZ 520 500 00)
Kto 40 622 04 005

Fachausschuß Elektrotechnik
der Zentralstelle für Unfallverhütung und Arbeitsmedizin
des Hauptverbandes der gewerblichen Berufsgenossenschaften

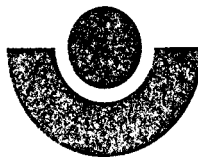

BG
Federführung:
Berufsgenossenschaft
der Feinmechanik
und Elektrotechnik

Fachausschuß Elektrotechnik, Postfach 51 05 80, 50941 Köln

SMA Regelsysteme GmbH
Hannoversche Straße 1-5

34266 Niestetal

Ihre Zeichen/Nachricht vom

Unser Zeichen (Bitte stets angeben)

Bearbeiter

☎ (02 21) 37 78-

Datum

UB.010.17(FA)

Bie-san

10.05.1999

Unbedenklichkeitsbescheinigung

Erzeugnis: *String-Wechselrichter*

Typ: *SWR 1500*
SWR 2000

Bestimmungsgemäße Verwendung: *Parallelbetrieb von Photovoltaikanlagen am*
EVU-Niederspannungsnetz

Prüfgrundlagen:

DIN EN 50178 (04.98) "Ausrüstung von Starkstromanlagen mit elektronischen
(VDE 0160) Betriebsmitteln"

DIN VDE 0558 Teil 1 "Halbleiter-Stromrichter; Allgemeine und besondere
(7.87) Bestimmungen für netzgeführte Stromrichter"

E DIN VDE 0126 "Selbsttätige Freischaltstelle für Photovoltaikanlagen einer
(10.97) Nennleistung $\leq 4,6$ kVA und einphasiger Paralleleinspeisung
über Wechselrichter in das Netz der öffentlichen Versorgung"

Die elektrische Sicherheit o. g. Erzeugnisse entspricht den zum Zeitpunkt der Ausstellung
dieser Bescheinigung geltenden Bestimmungen.

Diese Unbedenklichkeitsbescheinigung gilt befristet bis

31.12.2001.

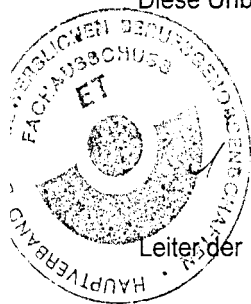

[Handwritten Signature]
- Peuker -
Leiter der Prüf- und Zertifizierungsstelle

Appendix 2: Information on SMA

Additional SMA literature for products in the Sunny Boy family⁴

- Technical Description of PV inverter Sunny Boy 700/850, Sunny Boy 1100 and Sunny Boy 2500
- User Manual for PC program Sunny Data
- User Manual for PC program Sunny Data Control
- User Manual for monitoring unit Sunny Boy Control
- Technical Description SWR-COM
- Sunny Boy INFO (periodical issues with up-to-date topics covering the Sunny Boy)
- SMA CD (products, technical documentation, drivers)
- Technical Description Powerline Communication

Sunny Boy on the Internet: <http://www.SMA.de>

For all users of SMA photovoltaic system components we have established a forum (Sunny Box) under <http://www.sma.de>. There you will find:

- Latest information on the Sunny Boys
- The latest version of Sunny Data for download
- The Sunny Boy service supports you in all matters related to your PV plant
- You can leave messages for SMA.

This is especially useful if you want to send the Sunny Boy Service files with recorded data of your PV-plant.

If you want to know more about SMA Regelsysteme GmbH and its products visit us on our homepage.

⁴ This literature can be ordered at a low price covering our expenses. All documents are also available on the Internet free of charge.